



# Balance multifonctionnelle HY10.30.H2.K



















WP-116-0064

More information on the website  
radwag.com/fr/info,w1,JVO



The drawings, photos and graphics used are for illustrative purposes only.

## Fonctions

-  Dosing
-  Labelling
-  Plus/Minus Control
-  Percent Weighing
-  Totalizing
-  Parts counting
-  Peak hold
-  Formulation
-  Newton unit measurement
-  Statistics
-  Checkweighing
-  GLP Procedures
-  Animal weighing
-  Differential weighing
-  Replaceable unit
-  Statistical Quality Control
-  ALIBI Memory
-  Transactions

## Paramètres Techniques

### Paramètres métrologiques

Capacité maximale [Max]	30 kg
Capacité minimale [Min]	200 g
Précision de lecture [d]	10 g
Échelon de légalisation [e]	10 g

Paramètres métrologiques	
Étendue de tare	-30 kg
Précision de lecture maximale pour les balances non vérifiées	1 g
Ajustage	externe
Classe de précision OIML	III
Paramètres physiques	
Afficheur	10,1" graphique couleurs écran tactile
Longueur de câble	1,5 m
Dimension du plateau	250x300 mm
Dimensions de colis L x P x H	350x560x500 mm
Masse nette	10 kg
Masse brute	11,5 kg
Construction	
Degré de protection	IP 66 / 67 construction, IP 66 / 67 / 69 terminal
Interface de Communication	
Interface de Communication	2xRS232, 2xUSB-A, Ethernet, 4 IN / 4 OUT (numériques)
Interfaces optionnelles	module Wi-Fi 802.11 b/g/n, module Profibus (DP SLAVE), module RS485, module PROFINET (RJ45), module de sorties analogiques (4-20mA, 0-20mA, 0-10V) , 12IN / 12OUT (IN – 5-24 VDC, OUT – max 30 VDC, 0,5 ADC)
Paramètres électriques	
Alimentation	100 – 240 V AC 50/60 Hz
Conditions environnementales	
Température du travail	-10 – +40 °C
Humidité relative d'air	10% – 85% RH sans condensation

\* Wi-Fi® is a registered trademark of Wi-Fi® Alliance.



Additional fee for verification



## Accessoires (Additional Fee)

Câbles RS 232 (balance – imprimante)  
 Plateaux avec les convoyeurs à rouleaux  
 Lecteurs de cartes à transpondeur  
 Câbles RS 232 (balance – imprimante ZEBRA)  
 Câbles de réseau (balance – Ethernet)  
 Afficheurs  
 Câbles RS 232, RS 485  
 Câbles d'Entrées/ de Sorties  
 Lecteurs de code-barres

Imprimantes d'étiquettes  
 Supports, Statifs, bras-supports  
 Claviers, manipulateurs  
 Imprimante de tickets de caisse  
 Poids de classe F1 -  
 cylindrique à bouton sans cavité d'ajustage, ensembles  
 Câble USB (balance – imprimante)  
 Modules de plateforme supplémentaires  
 Modules complémentaires  
 Convertisseur RS 232 – USB

## Software (Additional Fee)

• E2R Pesages [WX-010-0099]  
 • E2R CPP [WX-010-0051]

• E2R Recettes [WX-010-0043]  
 • E2R Registre [WX-010-0038]

- RAD Key [WX-010-0005]
- Éditeur D'étiquettes R02 [WX-010-0094]
- R-LAB [WX-010-0080]
- RADWAG Studio du Développement [WX-010-0104]

- Audit Trail Reader [WX-010-0186]
- RADWAG Remote Desktop [WX-010-0107]
- Éditeur de Balances 2.1 [WX-010-0173]

## Dimensions d'appareil L x P x H

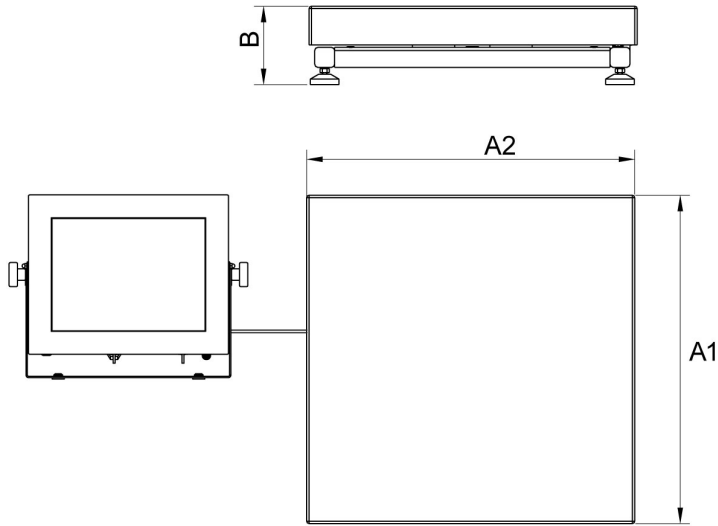

H Platform

Scale type	A1	A2	B
HY10 H1.K	200	150	85 ±3
HY10 H2.K	250	300	103 ±3
HY10 H3.K	410	410	98 ±2
HY10 H4.K	500	500	155 ±5
HY10 H5.K	600	600	155 ±5
HY10 H6.K	800	800	135 ±5

dimensions in mm

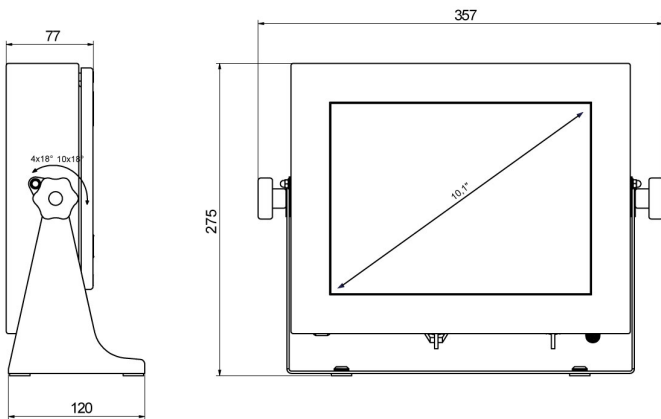

PUE HY10