



More information on the website  
radwag.com/fr/info,w1,JCI

# Balance multifonctionnelle C32.1,5.F1.M



The drawings, photos and graphics used are for illustrative purposes only.

## Fonctions



Labelling



Plus/Minus Control



Percent Weighing



Totalizing



Parts counting



Newton unit measurement



Statistics



IR sensors



GLP Procedures



Replaceable unit



ALIBI Memory

## Paramètres Techniques

Paramètres métrologiques	
Capacité maximale [Max]	1,5 kg
Capacité minimale [Min]	10 g
Précision de lecture	0,5 g
Étendue de tare	-1,5 kg
Précision de lecture maximale pour les balances non vérifiées	0,2 g
Classe de précision OIML	III

Paramètres physiques	
Afficheur	5" graphique couleurs
Dimension du plateau	300×300 mm
Dimensions de colis	570×390×170 mm
Masse nette	5,3 kg
Masse brute	6,6 kg
Construction	
Degré de protection	IP 65 construction, IP 43 terminal
Construction	acier pulvériséacier St3S
Matériel du plateau	Acier inoxydable AISI304
Interface de Communication	
Interface de Communication	2×RS232, USB-A, USB-B, Ethernet, 4 IN / 4 OUT (numériques), Wi-Fi
Paramètres électriques	
Alimentation	100 – 240 V AC 50/60 Hz
Prise de courant maximale	10 W
Alimentation optionnelle	accumulateur interne
Temps de travail avec l'alimentation d'accumulateur	5 heures
Conditions environnementales	
Température du travail	-10 – +40 °C

\* Equipement en option avec supplément de prix

\* Wi-Fi® is a registered trademark of Wi-Fi® Alliance.



Extra payment for verification



## Accessoires

Afficheurs  
Alimentateurs  
Câbles RS 232 (balance – imprimante)  
Câbles d'alimentation de cigare-allume  
Lecteurs de code-barres  
Câbles RS 232, RS 485  
Imprimantes d'étiquettes  
Afficheurs

Afficheurs  
Claviers, manipulateurs  
Supports, Statifs, bras-supports  
Modules complémentaires  
Imprimante de tickets de caisse  
Câbles RS 232, RS 485  
Câbles RS 232 (balance – imprimante)

## Software

- E2R Pesages [WX-010-0099]
- RAD Key [WX-010-0005]
- Alibi Reader [WX-010-0114]
- Éditeur de Balances 2.1 [WX-010-0173]

- E2R Registre [WX-010-0038]
- Éditeur D'étiquettes R02 [WX-010-0094]
- R-LAB [WX-010-0080]
- RADWAG Studio du Développement [WX-010-0104]

## Dimensions d'appareil

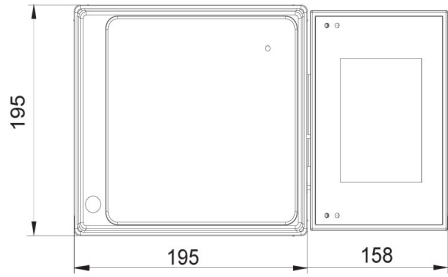
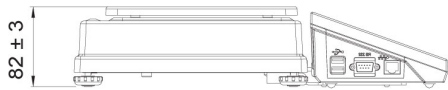

C32.D2

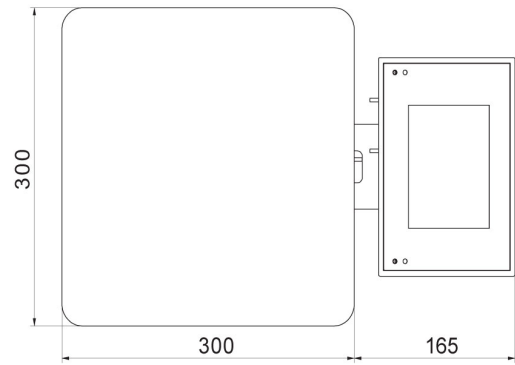
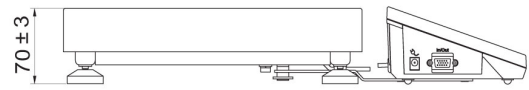

C32.F1.R

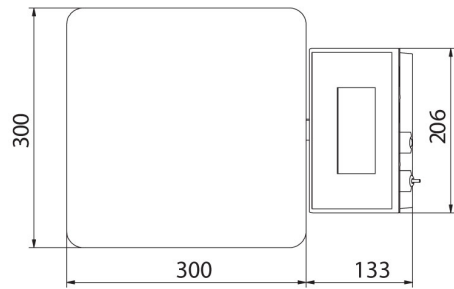
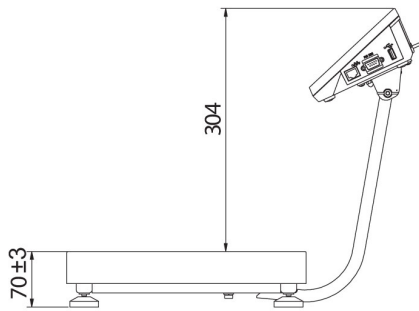

C32.F1.M

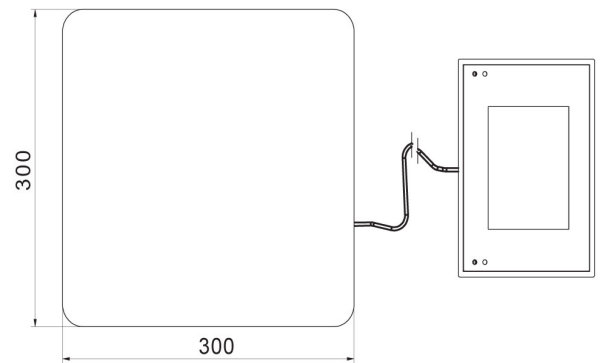
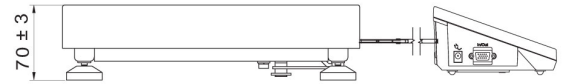

C32.F1.K