



More information on the website
radwag.com/fr/info,w1,JAR

Balance mono capteur C315.3.F1.R

WP-123-0006



The drawings, photos and graphics used are for illustrative purposes only.

Fonctions

 Plus/Minus Control

 Percent Weighing

 Totalizing

 Parts counting

 Internal battery

 Peak hold

 Newton unit measurement

 GLP Procedures

 Animal weighing

 ALIBI Memory

Paramètres Techniques

Paramètres métrologiques

Capacité maximale [Max]	3 kg
Capacité minimale [Min]	20 g
Précision de lecture [d]	1 g
Échelon de légalisation [e]	1 g
Étendue de tare	-3 kg
Précision de lecture maximale pour les balances non vérifiées	0,2 g
Classe de précision OIML	III

Paramètres physiques	
Afficheur	LCD (rétro-éclairé)
Dimension du plateau	300×300 mm
Dimensions de colis	570×390×170 mm
Masse nette	5,3 kg
Masse brute	7 kg
Construction	
Degré de protection	IP 65 construction, IP 43 terminal
Construction	acier pulvériséacier St3S
Matériel du plateau	Acier inoxydable AISI304
Interface de Communication	
Interface de Communication	RS232
Interfaces optionnelles	RS232
Paramètres électriques	
Alimentation	100 – 240 V AC 50/60 Hz + accumulateur
Prise de courant maximale	5 W
Temps de travail avec l'alimentation d'accumulateur	max 8h
Conditions environnementales	
Température du travail	-10 – +40 °C
Température de stockage	-10 – +50 °C
Humidité relative d'air	10% – 85% RH sans condensation
Terminal	C315



Additional fee for verification



Accessoires (Additional Fee)

Tables antivibratoires
Alimentateurs
Câbles RS 232 (balance – imprimante)
Câbles d'alimentation de cigare-allume
Afficheurs
Afficheurs
Câbles RS 232, RS 485
Convertisseur RS 232 – Ethernet

Sorties de boucle de courant AP2-1
Câbles RS 232, RS 485
Convertisseur RS 232 – USB
Câbles RS 232 (balance – imprimante)
Convertisseur RS 232 – RS 485
Imprimante de tickets de caisse
Supports, Statifs, bras-supports

Software (Additional Fee)

- RAD Key [WX-010-0005]
- R-LAB [WX-010-0080]

- R Panel [WX-010-0187]
- Éditeur de Balances 2.1 [WX-010-0173]

Dimensions d'appareil



C315.F1.M

C315.F1.R

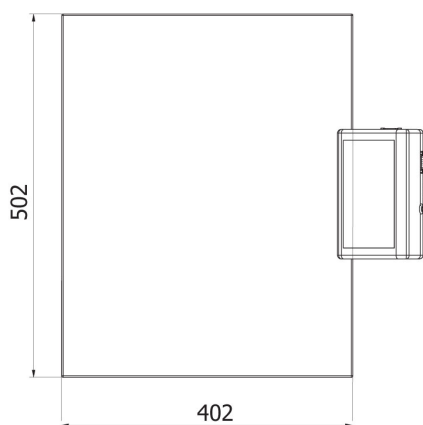
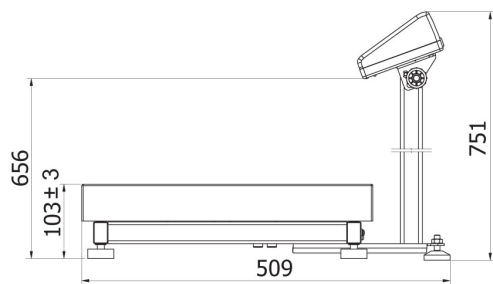

C315.C2.M

C315.C2.K