



More information on the website
radwag.com/en/info,w1,l36

C32.0.6.D2 Multifunctional Scale



The drawings, photos and graphics used are for illustrative purposes only.

Functions



Labelling



Plus/Minus Control



Percent Weighing



Totalizing



Parts counting



Newton unit measurement



Statistics



IR sensors



GLP Procedures



Replaceable unit



ALIBI Memory

Datasheet

| Metrological parameters | |
|--|---------|
| Maximum capacity [Max] | 0.6 kg |
| Minimum load | 4 g |
| Readability [d] | 0.2 g |
| Tare range | -0.6 kg |
| Max readability for non-verified scale | 0.02 g |
| OIML Class | III |

| Physical parameters | |
|-----------------------------|--|
| Display | 5" graphic colour |
| Cable length | 1 m |
| Weighing pan dimensions | 195×195 mm |
| Packaging dimensions | 530×310×150 mm |
| Net weight | 3.4 kg |
| Gross weight | 4 kg |
| Construction | |
| Protection class | IP 43 |
| Housing | ABS plastic |
| Weighing pan material | Stainless steel AISI304 |
| Communication interface | |
| Communication interface | 2×RS232, USB-A, USB-B, Ethernet, 4 IN / 4 OUT (digital), Wi-Fi |
| Electrical parameters | |
| Power supply | 100 – 240 V AC 50/60 Hz |
| Power consumption max. | 10 W |
| Optional power supply | internal rechargeable battery |
| Operation time on batteries | operation time up to 5 h |
| Environmental conditions | |
| Operating temperature | -10 – +40 °C |

* Optional equipment at additional cost

* Wi-Fi® is a registered trademark of Wi-Fi® Alliance.



Extra payment for verification



Accessories

Displays
 Power Adapters
 RS 232 cables (scale - printer)
 Cigarette lighter receptacle power supply cables
 Barcode scanners
 RS 232, RS 485 cables
 Label Printers
 Displays

Displays
 Keypad, external switches
 Stands, wall mounting kits and mounting brackets
 Additional modules
 Receipt Printer
 RS 232, RS 485 cables
 RS 232 cables (scale - printer)

Software

- E2R Weighing [WX-010-0099]
- RAD Key [WX-010-0005]
- Alibi Reader [WX-010-0114]
- Scale Editor 2.1 [WX-010-0173]

- E2R Weighing Records [WX-010-0038]
- Label Editor R02 [WX-010-0094]
- R-Lab [WX-010-0080]
- RADWAG Development Studio [WX-010-0104]

Device dimensions

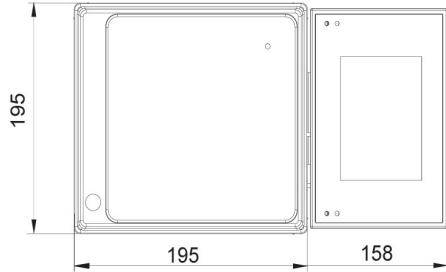

C32.D2

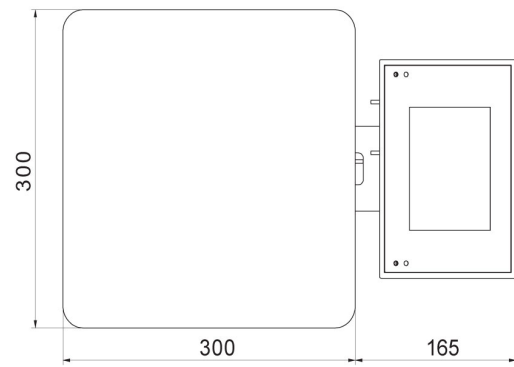
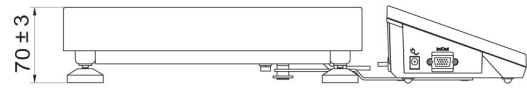

C32.F1.R

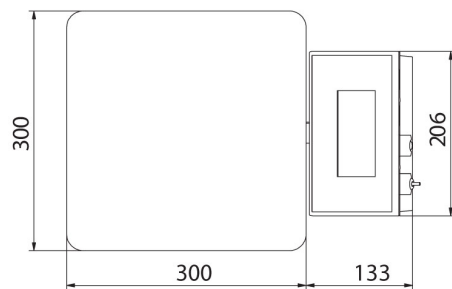
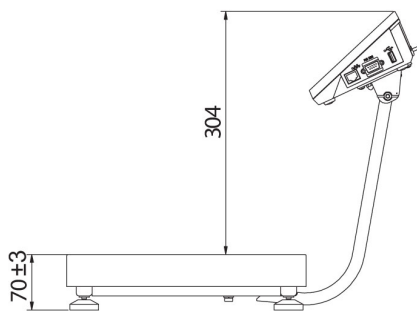

C32.F1.M

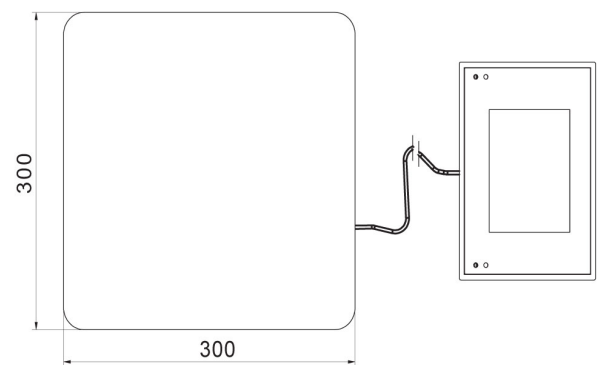
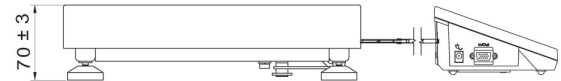

C32.F1.K