



More information on the website
radwag.com/de/info,w1,l36

Multifunktionswaage C32.0,6.D2



The drawings, photos and graphics used are for illustrative purposes only.

Funktionen



Labelling



Plus/Minus Control



Percent Weighing



Totalizing



Parts counting



Newton unit measurement



Statistics



IR sensors



GLP Procedures



Replaceable unit



ALIBI Memory

Technische Daten

Messtechnische Parameter	
Wägebereich [Max]	0,6 kg
Min. Belastung	4 g
Zifferschritt [d]	0,2 g
Tarierbereich	-0,6 kg
Max Ablesbarkeit [d] bei nicht geeichter Waage	0,02 g
OIML-Klasse	III

Physikalische Parameter	
Display	5" grafisch farbiger
Waagschale	195×195 mm
Verpackungsgröße	530×310×150 mm
Nettogewicht	3,4 kg
Bruttogewicht	4 kg
Kabellänge	1 m
Konstruktion	
Schutzart	IP 43
Gehäuse	ABS Kunststoff
Waageschale	Edelstahl AISI304
Kommunikationsschnittstellen	
Schnittstellen	2×RS232, USB-A, USB-B, Ethernet, 4 IN / 4 OUT (Digitalausgang), Wi-Fi
Elektrische Parameter	
Stromversorgung	100 – 240 V AC 50/60 Hz
Maximaler Leistungsaufnahme	10 W
Optionale Stromversorgung	interner Akkumulator
Akku-Betriebszeit	bis zu 5 Stunden Dauerbetrieb
Umgebungsbedingungen	
Umgebungstemperatur	-10 ÷ +40 °C

* - Option gegen Aufpreis

* Wi-Fi® is a registered trademark of Wi-Fi® Alliance.



Extra payment for verification



Zubehör

Displays
 Netzteile
 Kabel RS 232 (Waage – Drucker)
 Anschlusskabel für Zigarettenanzünder
 Barcodescanner
 Kabel RS 232, RS 485
 Etikettendrucker
 Displays

Displays
 Tastaturen, Taster
 Stative, Ausleger
 Zusätzliche Module
 Thermische Drucker
 Kabel RS 232, RS 485
 Kabel RS 232 (Waage – Drucker)

Software

- E2R Wägung [WX-010-0099]
- RAD Key [WX-010-0005]
- Alibi Reader [WX-010-0114]
- Scale Editor 2.1 [WX-010-0173]

- E2R Evidenz [WX-010-0038]
- Etiketten-Editor R02 [WX-010-0094]
- RLAB [WX-010-0080]
- RADWAG Development Studio [WX-010-0104]

Abmessungen des Geräts

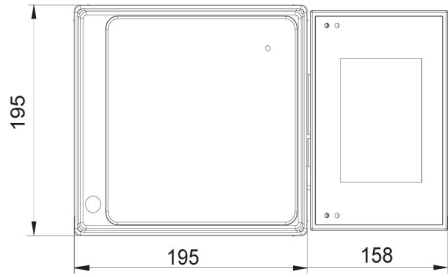
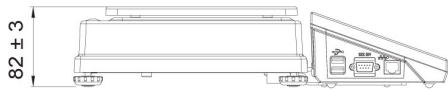

C32.D2

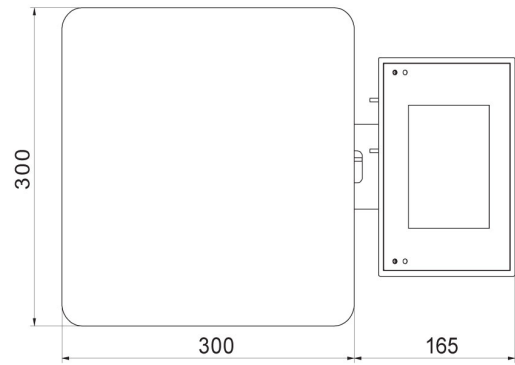
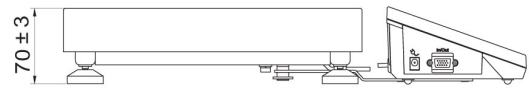

C32.F1.R

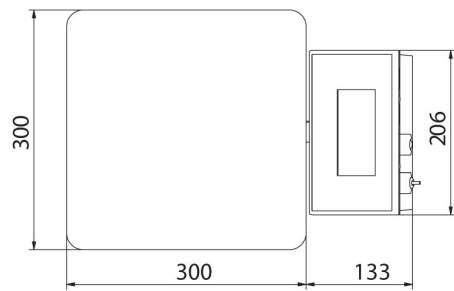
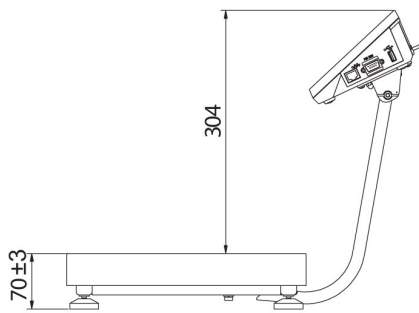

C32.F1.M

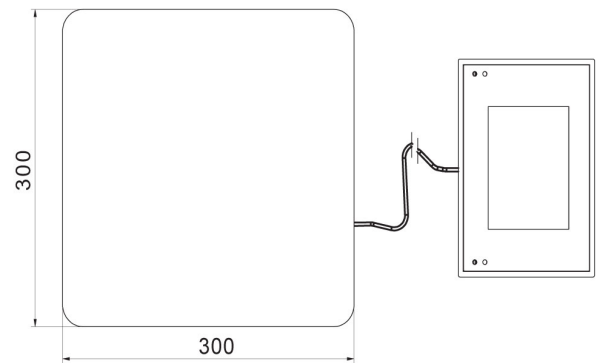
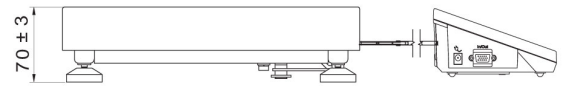

C32.F1.K