



Plataforma multifuncional C32.0.6.D2

WP-120-0005

More information on the website
radwag.com/br/info,w1,l36



The drawings, photos and graphics used are for illustrative purposes only.

Funções



Labelling



Plus/Minus Control



Percent Weighing



Totalizing



Parts counting



Newton unit measurement



Statistics



IR sensors



GLP Procedures



Replaceable unit



ALIBI Memory

Ficha Técnica

| Parâmetros metrológicos | |
|---|---------|
| Capacidade máxima [máx] | 0,6 kg |
| Carga mínima | 4 g |
| Resolução [d] | 0,2 g |
| Faixa de tara | -0,6 kg |
| Resolução máxima para plataforma não verificada | 0,02 g |
| Classe OIML | III |

| Parâmetros físicos | |
|----------------------------------|--|
| Display | 5" gráfico colorida |
| Comprimento até cabo | 1 m |
| Dimensões até prato de pesagem | 195×195 mm |
| Dimensões da embalagem L x P x A | 530×310×150 mm |
| Peso líquido | 3,4 kg |
| Peso bruto | 4 kg |
| Construção | |
| Classe de proteção | IP 43 |
| Carcaça | plástico ABS |
| Material até prato de pesagem | aço inoxidável AISI304 |
| Interface de comunicação | |
| Interface de comunicação | 2×RS232, USB-A, USB-B, Ethernet, 4 IN / 4 OUT (digital), Wi-Fi |
| Parâmetros elétricos | |
| Fonte de alimentação | 100 – 240 V AC 50/60 Hz |
| Consumo de energia máx. | 10 W |
| Fonte de alimentação opcional | bateria interna recarregável |
| Tempo de operação com baterias | tempo de operação até 5 h |
| Condições ambientais | |
| Temperatura de operação | -10 – +40 °C |

* Wi-Fi® is a registered trademark of Wi-Fi® Alliance.



Additional fee for verification



Acessórios (Additional Fee)

Displays

Adaptadores de energia

Cabos de alimentação para acendedor de cigarro automotivo

!Leitores de código de barras

RS 232, RS 485 cabos

Impressoras de etiquetas

Mesas antivibração

Teclado, interruptores externos

Módulos adicionais

Impressora de recibos

Cabos RS 232 (plataforma - impressora)

Software (Additional Fee)

• E2R Pesagem [WX-010-0099]

• Editor de etiquetas R02 [WX-010-0094]

• R-Lab [WX-010-0080]

• RAD Key [WX-010-0005]

• Leitor Alibi [WX-010-0114]

• RADWAG Development Studio [WX-010-0104]

Dimensões do dispositivo L x P x A

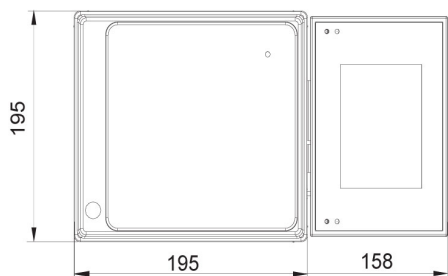
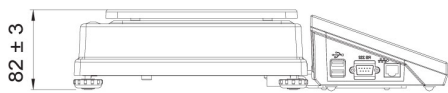

C32.D2

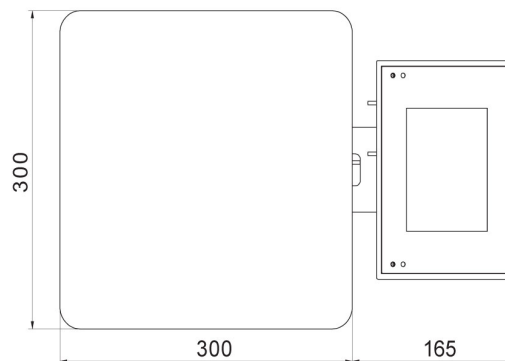
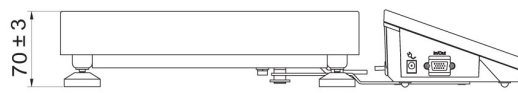

C32.F1.R

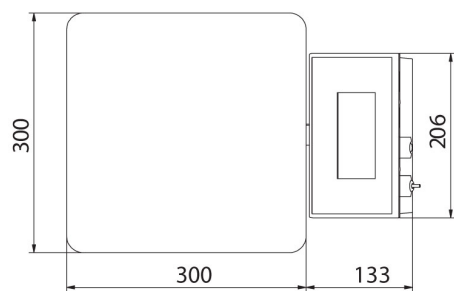
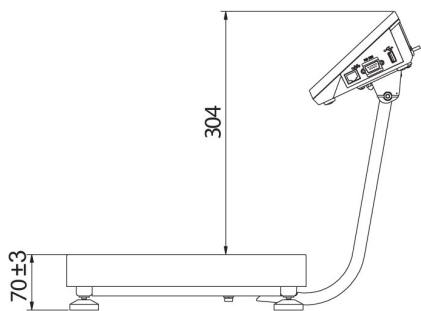

C32.F1.M

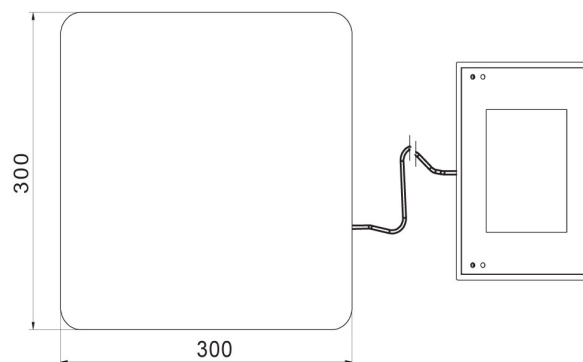
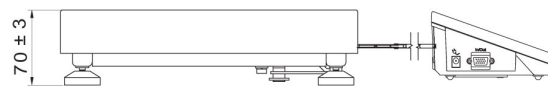

C32.F1.K