



More information on the website  
radwag.com/es/info,w1,GN8

# Báscula multifuncional C32.15.D2

WP-120-0035



The drawings, photos and graphics used are for illustrative purposes only.

## Funciones



Etiquetado



Control más/menos



Desviaciones porcentuales



Resumiendo pesajes



Contar piezas



Medición en Newtons



Estadísticas



Sensores infrarrojos



Procedimientos GLP



Unidades intercambiables



Memoria Alibi

## Datos técnicos

Parámetros metrológicos	
Maxima capacidad [Max]	15 kg
Minima capacidad	100 g
Legibilidad [d]	5 g
Rango de tara	-15 kg
Legibilidad máxima para las balanzas no verificadas	0,5 g
Clase OIML	III

Paramètros físicos	
Pantalla	5" gráfico color
Longitud del cable	1 m
Dimensión de platillo	195×195 mm
Dimensiones de embalaje	530×310×150 mm
Masa neta	3,4 kg
Masa bruta	4,3 kg
Construcción	
Grado de protección	IP 43
Chasis	material ABS
Material del platillo	Acero inoxidable AISI304
Interface de comunicación	
Conectividad	2×RS232, USB-A, USB-B, Ethernet, 4 IN / 4 OUT (digitales), Wi-Fi
Parámetros electricos	
Alimentacion	100 – 240 V AC 50/60 Hz
Consumo máximo de potencia	10 W
Corriente de alimentación adicional	batería interna
Horas de trabajo con baterias	5 horas
Condiciones ambientales	
Temperatura de trabajo	-10 – +40 °C

\*Equipo opcional con costo adicional

\* Wi-Fi® is a registered trademark of Wi-Fi® Alliance.



Additional fee for verification



## Accesorios (Additional Fee)

Pantallas  
 Adaptadores de corriente  
 Cables RS 232 (Bascula a Impresora)  
 Cables de corriente desde mechero de automóvil  
 Escáner de códigos de barra  
 Cables RS 232, RS 485  
 Impresoras de etiquetas  
 Pantallas

Pantallas  
 Teclado, manipuladores  
 Soportes, brazos  
 Módulos adicionales  
 Impresoras de recibos  
 Cables RS 232, RS 485  
 Cables RS 232 (Bascula a Impresora)

## Programas (Additional Fee)

- E2R Pesajes [WX-010-0099]
- RAD Key [WX-010-0005]
- Alibi Reader PC Software [WX-010-0114]
- Editor de Balanzas 2.1 [WX-010-0173]

- E2R Registro [WX-010-0038]
- Editor de Etiquetas R02 [WX-010-0094]
- R-LAB [WX-010-0080]
- RADWAG Development Studio [WX-010-0104]

# Dimensiones de aparato

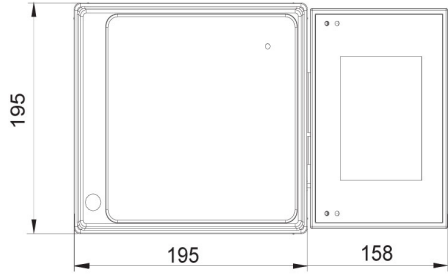
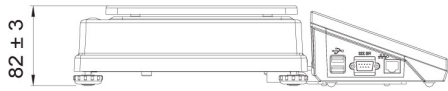

C32.D2

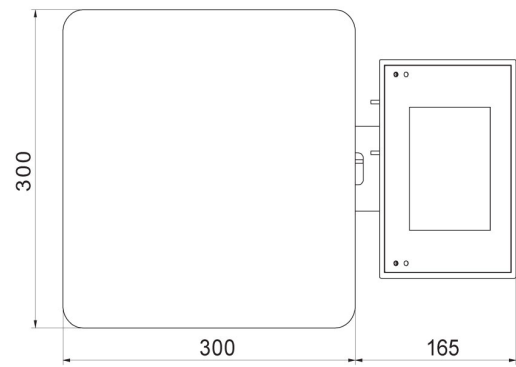
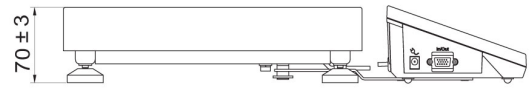

C32.F1.R

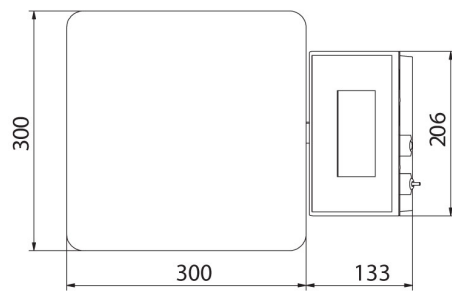
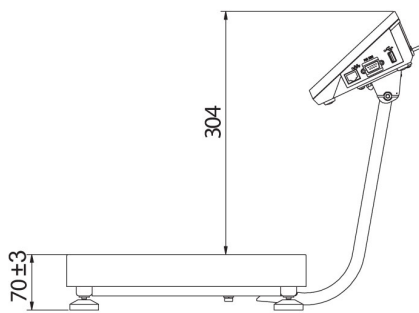

C32.F1.M

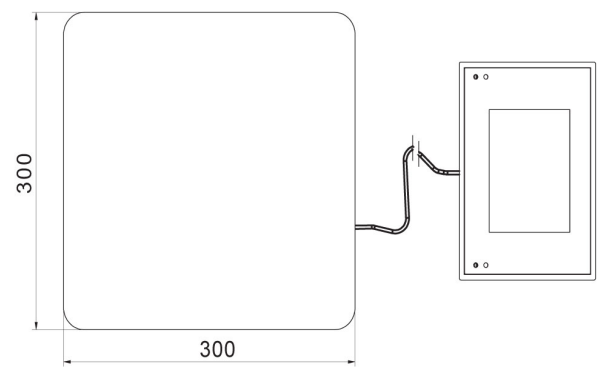
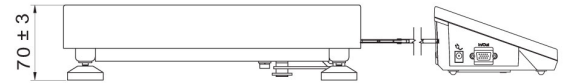

C32.F1.K