



More information on the website  
[radwag.com/it/info,w1,GJA](http://radwag.com/it/info,w1,GJA)

# Basamento versione „waterproof” con cella di carico in acciaio inox H315.60.HR3.M



The drawings, photos and graphics used are for illustrative purposes only.

## Funzioni

 Plus/Minus Control

 Percent Weighing

 Totalizing

 Parts counting

 Internal battery

 Peak hold

 Newton unit measurement

 Animal weighing

## Specifiche

### Parametri metrologici

Portata massima [Max]	60 kg
Portata minima [Min]	400 g
Divisione [d]	20 g
Intervallo di verifica della bilancia [e]	20 g
Campo di tara	-60 kg
Massima leggibilità per bilance non verificate	2 g
Classe OIML	III

### Parametri fisici

Display	LCD (backlit)
---------	---------------

Parametri fisici	
Dimensione piatto	410x410 mm
Dimensioni del pacco	510x510x270 mm
Peso netto	15,5 kg
Peso lordo	17,3 kg
Costruzione	
Punteggio IP	IP 68 construction, IP 68 cell, IP 68 (1h max)/69 terminal
Costruzione	Stainless steel AISI316
Interfaccia di comunicazione	
Interfaccia	RS232, USB
Interfacce opzionali	RS232 or RS485 or 4IN/4OUT or Ethernet or analog output 4-20 mA
Parametri elettrici	
Alimentatore	100 – 240 V AC 50/60 Hz
Alimentatore opzionale	internal rechargeable battery
Tempo operativo delle batterie	max 7h
Environmental conditions	
Ambiente di lavoro	-10 – +40 °C
Temperatura di stoccaggio	-25 – +70 °C
Umidità relativa	10% – 85% RH no condensation



Extra payment for verification



## Accessori

Cavo seriale RS 232 (connessione bilance - Stampanti)  
 Tavoli antivibranti  
 Display  
 Cavo seriale RS 232 (connessione bilance - Ethernet)  
 Cavo seriale RS 232, RS 485  
 RS 232 – Ethernet Converter  
 USB adatper

Stampanti di ricevuta  
 cavo USB (connessione bilance - stampanti)  
 Supporto, set di montaggio a muro e braccetti di montaggio  
 RS 232 – USB Converter  
 Banco a rulli  
 Cavo seriale RS 232, RS 485

## Software

- RAD Key [WX-010-0005]
- R-LAB [WX-010-0080]

- R Panel [WX-010-0187]
- Editore per sistemi di pesatura 2.1 [WX-010-0173]

## Device dimensions

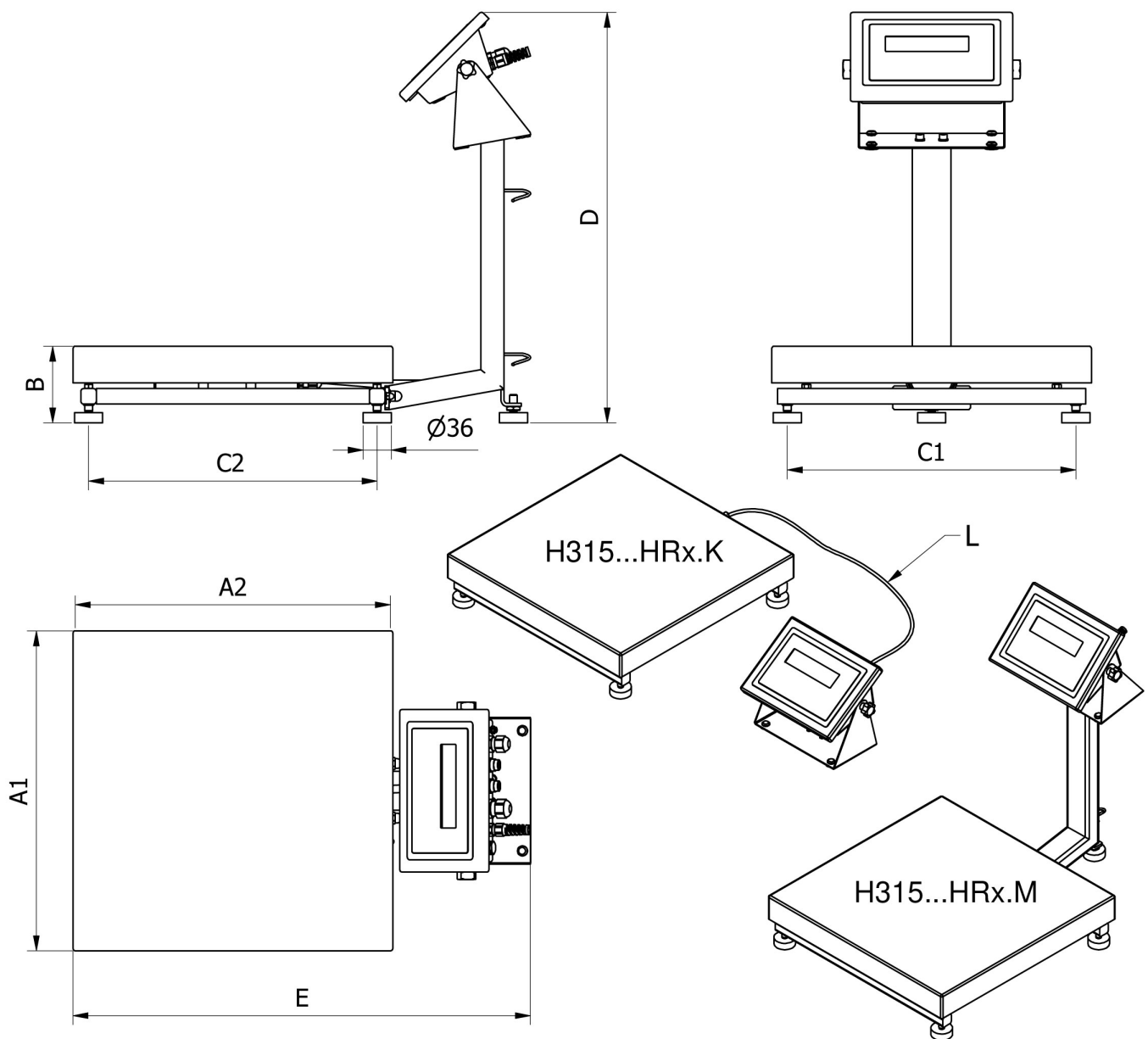

		A1	A2	B	C1	C2	D	E	L
H315...HR2.M	250 x 300	246	306	104 ± 3	208	268	~525	~483	
H315...HR2.K	250 x 300	246	306	104 ± 3	208	268	-	-	1,5m
H315...HR3.M	410 x 410	410	410	98 ± 2	370	370	~525	~587	
H315...HR3.K	410 x 410	410	410	98 ± 2	370	370	-	-	2,5m
H315...HR4.M	500 x 500	497	497	155 ± 5	400	400	~767	~650	
H315...HR4.K	500 x 500	497	497	155 ± 5	400	400	-	-	2,5m
H315...HR3/5.M	400 x 600	597	397	155 ± 5	500	300	~767	~550	
H315...HR3/5.K	400 x 600	597	397	155 ± 5	500	300	-	-	2,5m
H315...HR5.M	600 x 600	597	597	155 ± 5	500	500	~767	~750	
H315...HR5.K	600 x 600	597	597	155 ± 5	500	500	-	-	2,5m