



More information on the website
radwag.com/de/info,w1,FTO

Multifunktionswaage HY10.150.H4.K



The drawings, photos and graphics used are for illustrative purposes only.

Funktionen

-  Dosing
-  Labelling
-  Plus/Minus Control
-  Percent Weighing
-  Totalizing
-  Parts counting
-  Peak hold
-  Formulation
-  Newton unit measurement
-  Statistics
-  Checkweighing
-  GLP Procedures
-  Animal weighing
-  Differential weighing
-  Replaceable unit
-  Statistical Quality Control
-  ALIBI Memory
-  Transactions

Technische Daten

Messtechnische Parameter

Wägebereich [Max]	150 kg
Min. Belastung	1 kg
Zifferschritt [d]	50 g
Eichwert [e]	50 g

Messtechnische Parameter	
Tarierbereich	-150 kg
Max Ablesbarkeit [d] bei nicht geeichter Waage	5 g
Justierung	extern
OIML-Klasse	III
Physikalische Parameter	
Display	10,1" grafisch farbiger Touchscreen
Kabellänge	2,5 m
Waagschale	500×500 mm
Verpackungsgröße	610×610×560 mm
Nettogewicht	24 kg
Bruttogewicht	26 kg
Konstruktion	
Schutzart	IP 68 Konstruktion, IP 68 (1h max)/69 Messgerät
Kommunikationsschnittstellen	
Schnittstellen	2×RS232, 2×USB-A, Ethernet, 4 IN / 4 OUT (Digitalausgang)
Optionale Schnittstellen	Modul Wi-Fi 802.11 b/g/n, Modul Profibus (DP SLAVE), Modul RS485, Modul PROFINET (RJ45), Analogausgangsmodul (4-20mA, 0-20mA, 0-10V) , 12IN / 12OUT (IN – 5-24 VDC, OUT – max 30 VDC, 0,5 ADC)
Elektrische Parameter	
Stromversorgung	100 – 240 V AC 50/60 Hz
Umgebungsbedingungen	
Umgebungstemperatur	-10 – +40 °C
Relative Luftfeuchtigkeit	10% – 85% RH ohne Kondensation

* Wi-Fi® is a registered trademark of Wi-Fi® Alliance.



Extra payment for verification



Zubehör

Kabel RS 232 (Waage – Drucker)
 Transponderkartenleser
 Kabel RS 232 (Waage – Drucker ZEBRA)
 Netzkabel (Waage – Ethernet)
 Displays
 Kabel RS 232, RS 485
 E/A Kabel
 Barcode-Scanner
 Etikettendrucker

Wandhalterung, Stativ
 Tastaturen, Taster
 Thermische Drucker
 Prüfgewichte der F1 Klasse - Knopfgewichte, Sätze
 Rahmen mit Rollenförderern
 USB-Kabel (Waage – Drucker)
 Modul für zusätzliche Wägeplattformen
 Zusätzliche Module
 Konverter RS 232 – USB

Software

- E2R Wägung [WX-010-0099]
- E2R FPVO [WX-010-0051]
- RAD Key [WX-010-0005]
- Etiketten-Editor R02 [WX-010-0094]

- E2R Rezepturen [WX-010-0043]
- E2R Evidenz [WX-010-0038]
- Audit Trail Reader [WX-010-0186]
- Radwag Remote Desktop [WX-010-0107]

Abmessungen des Geräts

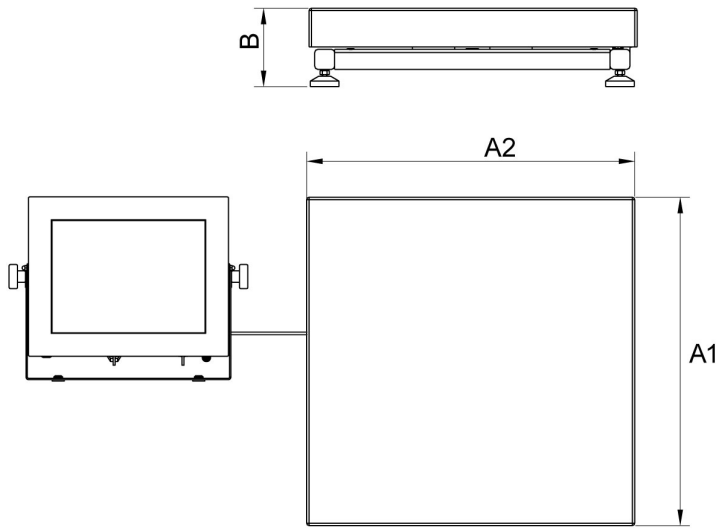

H Platform

Scale type	A1	A2	B
HY10 H1.K	200	150	85 ±3
HY10 H2.K	250	300	103 ±3
HY10 H3.K	410	410	98 ±2
HY10 H4.K	500	500	155 ±5
HY10 H5.K	600	600	155 ±5
HY10 H6.K	800	800	135 ±5

dimensions in mm

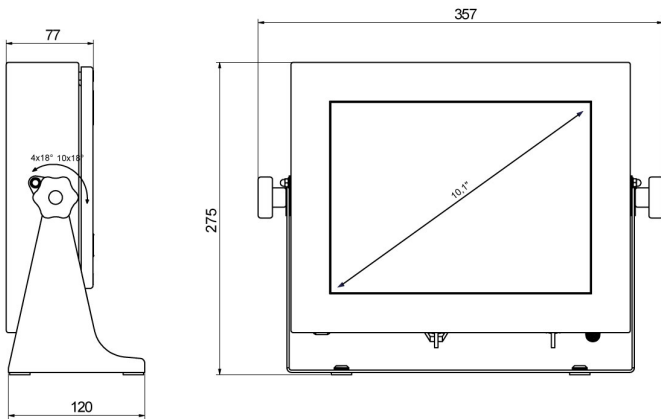

PUE HY10