

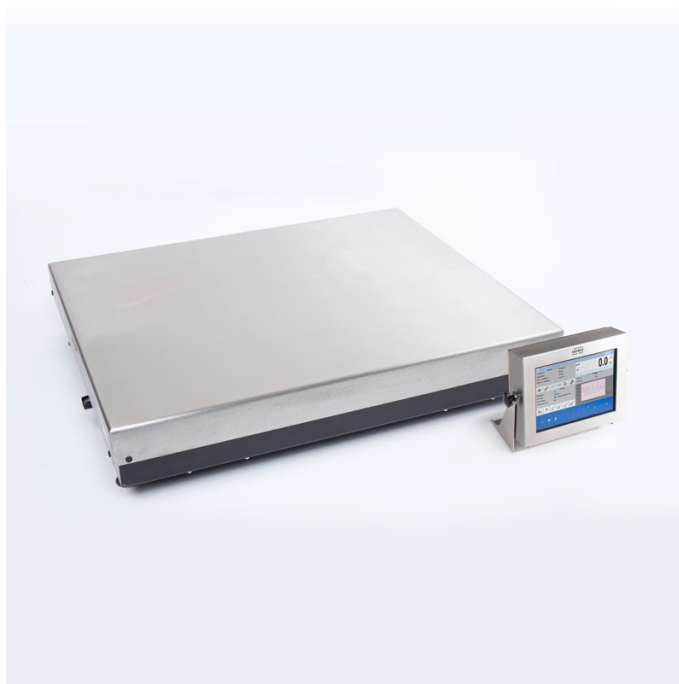



















More information on the website
radwag.com/it/info,w1,FLX

HY10.1100.HRP Basamenti ad alta risoluzione



The drawings, photos and graphics used are for illustrative purposes only.

funzioni

-  Dosing
-  Labelling
-  Plus/Minus Control
-  Percent Weighing
-  Totalizing
-  Parts counting
-  Peak hold
-  Formulation
-  Newton unit measurement
-  Statistics
-  Checkweighing
-  GLP Procedures
-  Animal weighing
-  Differential weighing
-  Replaceable unit
-  Statistical Quality Control
-  ALIBI Memory
-  Transactions

Foglio di calcolo

Parametri metrologici	
Capacità massima [Max]	1100 kg
Pesata minima	500 g
Intervallo di precarico	100 kg
Accuratezza	10 g

Parametri metrologici	
Intervallo di tara	-1100 kg
Ripetibilita	15 g
Linearita	±30 g
Tempo di stabilizzazione	3 s
Calibrazione	internal (automatic)
Parametri fisici	
Display	10" graphic colour touchscreen
Dimensioni del piatto di pesata	1000×800 mm
Dimensioni del pacco	1000×1200×666 mm
Peso netto	126 kg
Peso lordo	160 kg
Costruzione	
Punteggio IP	IP 66/67 construction, IP 68/69 indicator
Costruzione	mild steel St3S
Materiale da pesata	Stainless steel AISI304
Interfaccia di comunicazione	
Interfaccia	2×RS232, 2×USB-A, Ethernet, 4 IN / 4 OUT (digital)
Interfacce opzionali	module Wi-Fi 802.11 b/g/n, module Profibus (DP SLAVE), module RS485, module PROFINET (RJ45), analog output module (4-20mA, 0-20mA, 0-10V) , 12IN / 12OUT (IN – 5-24 VDC, OUT – max 30 VDC, 0,5 ADC)
Parametri elettrici	
Alimentatore	100 – 240 V AC 50/60 Hz
Environmental conditions	
Temperatura di lavoro	+10 ÷ +40 °C
Umidita atmosferica	40% ÷ 80%

* Wi-Fi® is a registered trademark of Wi-Fi® Alliance.



Accessori

Cavo seriale RS 232 (connessione bilance - Stampanti)
 Lettore di tessere transponder
 Cavo seriale RS 232 (connessione bilance - Stampanti ZEBRA)
 Cavo seriale RS 232 (connessione bilance - Ethernet)
 Display
 Cavo seriale RS 232, RS 485
 cavi IN/OUT
 Lettore di codici a barre

stampanti per etichette
 Supporto, set di montaggio a muro e braccetti di montaggio
 Tastiera, interruttori esterni
 Stampanti di ricevuta
 cavo USB (connessione bilance - stampanti)
 Moduli aggiuntivi della piattaforma
 Moduli aggiuntivi
 RS 232 – USB Converter

Software

• E2R Weighing [WX-010-0099]

• E2R Formulazione [WX-010-0043]

- E2R Weighing Records [WX-010-0038]
- Audit Trail Reader [WX-010-0186]
- RADWAG Remote Desktop [WX-010-0107]
- Editore per sistemi di pesatura 2.1 [WX-010-0173]

- RAD Key [WX-010-0005]
- Editore di etichette R02 [WX-010-0094]
- R-LAB [WX-010-0080]
- Software „Development Studio” RADWAG [WX-010-0104]

Device dimensions

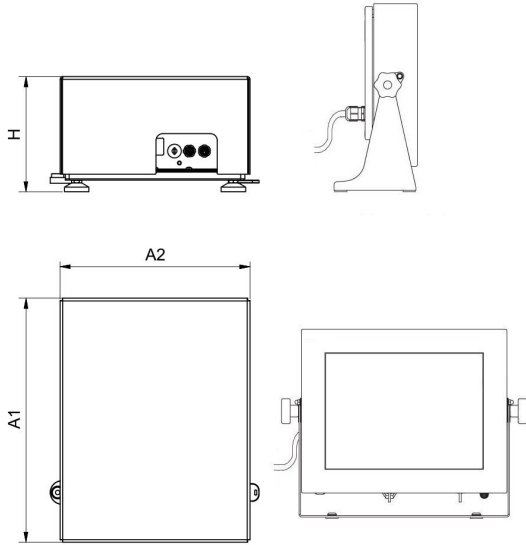

HY10.16 - 32.HRP

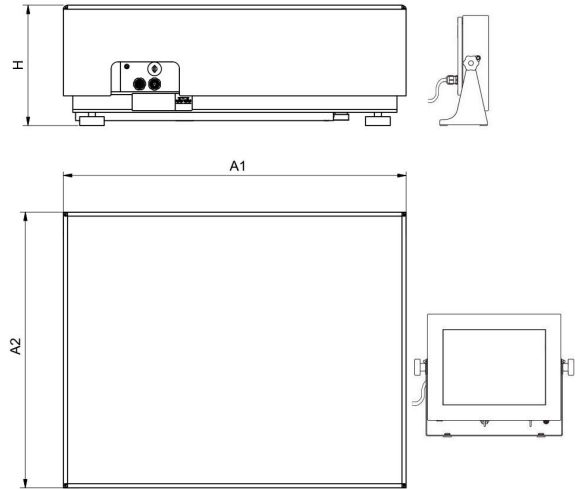

HY10.HRP

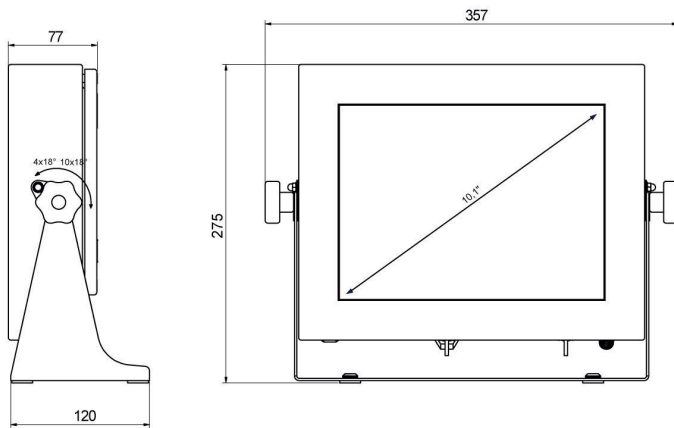

PUE HY10

Scale type	A1	A2	H
HY10.(16-32).HRP	360	280	180±5
HY10.(62-150).HRP	500	400	180±5
HY10.150.2.HRP	500	500	180±5
HY10.(150.1-300).HRP	800	600	180±5
HY10.(300.1-1100).HRP	1000	800	180±5
HY10.(2000).HRP	1250	1000	180±5

Dimensions in mm