

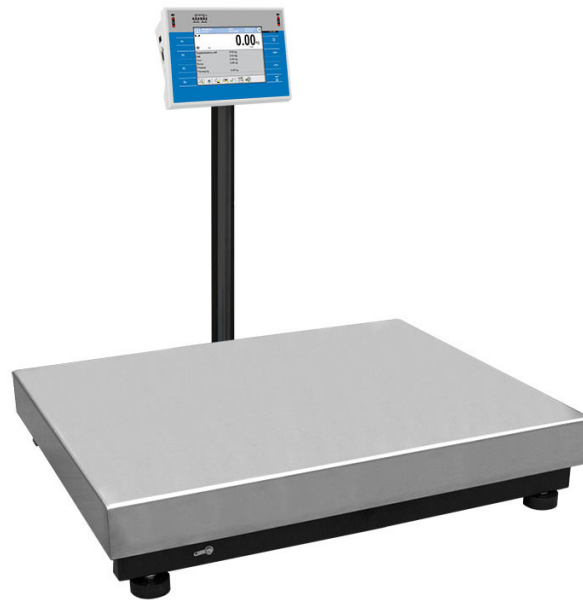

















More information on the website
radwag.com/es/info,w1,D75

Báscula multifuncional WPY 15/C2



The drawings, photos and graphics used are for illustrative purposes only.

Funciones

-  Dosificación
-  Etiquetado
-  Indicador más/menos
-  Desviaciones porcentuales
-  Suma de pesajes
-  Contar piezas
-  Cierre del pesaje máximo
-  Recetas
-  Medición en Newtons
-  Estadísticas
-  Controlador de peso
-  Sensores infrarrojos
-  Pesaje de animales
-  Pesaje diferencial
-  Memoria Alibi

Datos técnicos

Parámetros metrológicos	
Maxima capacidad [Max]	15 kg
Minima capacidad	100 g
Legibilidad [d]	5 g
Rango de tara	-15 kg
Legibilidad máxima para las balanzas no verificadas	0,5 g
Tiempo de estabilización	2 s

Parámetros metrológicos	
Calibración	externa
Clase OIML	III
Parámetros físicos	
Pantalla	5,7" Resistiv-Farb-Touchscreen
Dimensión de platillo	400×500 mm
Dimensiones de embalaje	720×620×210 mm
Masa neta	12,5 kg
Masa bruta	15 kg
Construcción	
Grado de protección	IP 43
Interface de comunicación	
Conectividad	2×RS232, 2×USB-A, Ethernet, 4 IN / 4 OUT (digitales), Wi-Fi
Parámetros electricos	
Alimentación	100 – 240 V AC 50/60 Hz
Condiciones ambientales	
Temperatura de trabajo	-10 ÷ +40 °C

* Wi-Fi® is a registered trademark of Wi-Fi® Alliance.



Extra payment for verification



Accesorios

Lector de tarjetas transpondedor
 Cables RS 232 (Bascula a Impresora)
 Cables de corriente desde mechero de automóvil
 Escáner de códigos de barra
 Cables RS 232, RS 485
 Impresoras de etiquetas
 Mesas antivibratil
 Pantallas
 Cables Entradas/Salidas

Teclado, manipuladores
 Soportes, brazos
 Impresoras de recibos
 Pesas de clase F1 - cilíndrico sin cámara de ajuste, juegos
 Salidas del bucle de corriente AP2-1
 Cables RS 232, RS 485
 Módulos adicionales de la plataforma
 Convertidor RS 232 a USB
 Cables RS 232 (Bascula a Impresora)

Programas

- E2R Pesajes [WX-010-0099]
- E2R CCE [WX-010-0051]
- RAD Key [WX-010-0005]
- Editor de Etiquetas R02 [WX-010-0094]
- R-LAB [WX-010-0080]
- RADWAG Development Studio [WX-010-0104]

- E2R Recetas [WX-010-0043]
- E2R Registro [WX-010-0038]
- Audit Trail Reader [WX-010-0186]
- RADWAG Remote Desktop [WX-010-0107]
- Editor de Balanzas 2.1 [WX-010-0173]

Dimensiones de aparato

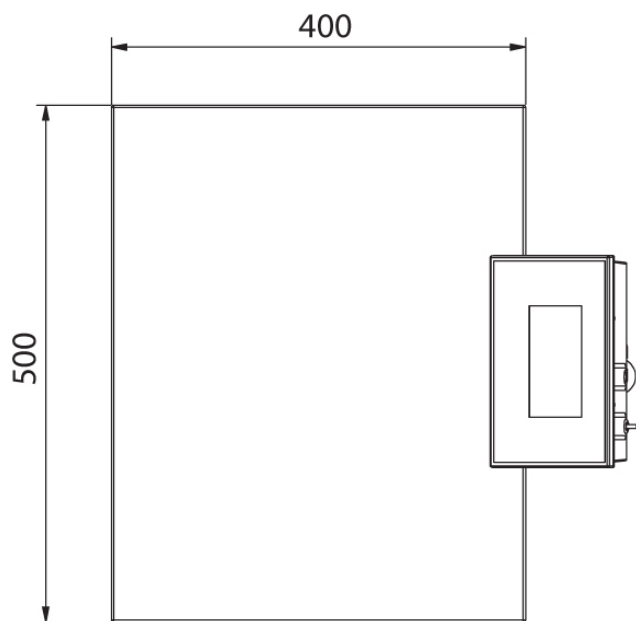
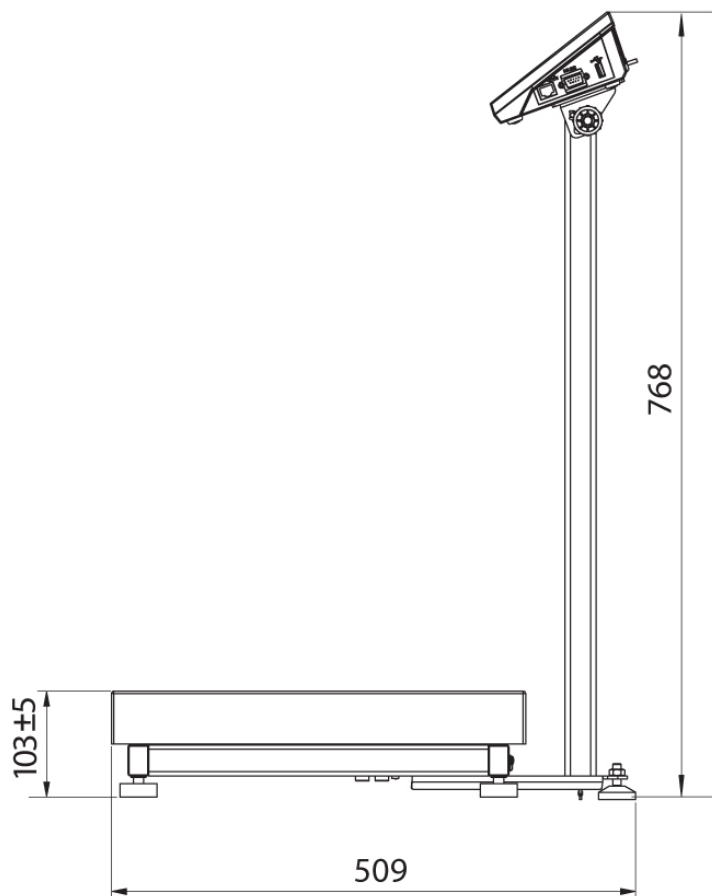

WPY C2/M