



More information on the website
radwag.com/br/info,w1,D3S



















Plataforma multifuncional HY10.30.H3.K

WP-116-0015



The drawings, photos and graphics used are for illustrative purposes only.

Funções

-  Dosing
-  Labelling
-  Plus/Minus Control
-  Percent Weighing
-  Totalizing
-  Parts counting
-  Peak hold
-  Formulation
-  Newton unit measurement
-  Statistics
-  Checkweighing
-  GLP Procedures
-  Animal weighing
-  Differential weighing
-  Replaceable unit
-  Statistical Quality Control
-  ALIBI Memory
-  Transactions

Ficha Técnica

Parâmetros metrológicos

Capacidade máxima [máx]	30 kg
Carga mínima	200 g
Resolução [d]	10 g
Unidade de verificação [e]	10 g

Parâmetros metrológicos	
Faixa de tara	-30 kg
Resolução máxima para plataforma não verificada	1 g
Ajuste	externa
Classe OIML	III
Parâmetros físicos	
Display	10,1" gráfico colorida tela touchscreen
Comprimento até cabo	2,5 m
Dimensões até prato de pesagem	410x410 mm
Dimensões da embalagem L x P x A	510x510x500 mm
Peso líquido	16 kg
Peso bruto	18 kg
Construção	
Classe de proteção	IP 66 / 67 construção, IP 66 / 67 / 69 terminal
Interface de comunicação	
Interface de comunicação	2xRS232, 2xUSB-A, Ethernet, 4 IN / 4 OUT (digital)
Interfaces opcionais	módulo Wi-Fi 802.11 b/g/n, módulo Profibus (DP SLAVE), módulo RS485, módulo PROFINET (RJ45), módulo de saída analógica (4-20mA, 0-20mA, 0-10V) , 12IN / 12OUT (IN – 5-24 VDC, OUT – max 30 VDC, 0,5 ADC)
Parâmetros elétricos	
Fonte de alimentação	100 – 240 V AC 50/60 Hz
Condições ambientais	
Temperatura de operação	-10 – +40 °C
Umidade relativa	10% – 85% RH sem condensação

* Wi-Fi® is a registered trademark of Wi-Fi® Alliance.



Additional fee for verification



Acessórios (Additional Fee)

Unidade de loop de corrente AP2-4
Mesas antivibração
Cabos de rede (plataforma - Ethernet)
Displays
Cabos IN/OUT
!Leitores de código de barras

Impressoras de etiquetas
Teclado, interruptores externos
Impressora de recibos
Pesos padrão F1 -
pesos botão sem câmara de ajuste, conjuntos
RS 232 – Conversor USB
!Mesa de rolos

Software (Additional Fee)

- E2R Pesagem [WX-010-0099]
- Leitor Audit Trail [WX-010-0186]
- RADWAG Remote Desktop [WX-010-0107]
- RADWAG Development Studio [WX-010-0104]

- RAD Key [WX-010-0005]
- Editor de etiquetas R02 [WX-010-0094]
- R-Lab [WX-010-0080]

Dimensões do dispositivo L x P x A



H Platform

Scale type	A1	A2	B
HY10 H1.K	200	150	85 ±3
HY10 H2.K	250	300	103 ±3
HY10 H3.K	410	410	98 ±2
HY10 H4.K	500	500	155 ±5
HY10 H5.K	600	600	155 ±5
HY10 H6.K	800	800	135 ±5

dimensions in mm

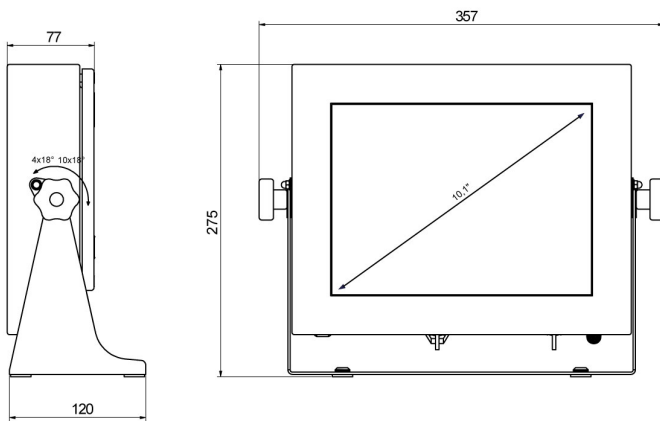

PUE HY10