

















More information on the website
radwag.com/fr/info,w1,CY3

Balance de précision WLY 2/D2



The drawings, photos and graphics used are for illustrative purposes only.

Fonctions

-  Dosing
-  Labelling
-  Plus/Minus Control
-  Percent Weighing
-  Totalizing
-  Parts counting
-  Peak hold
-  Formulation
-  Newton unit measurement
-  Statistics
-  Checkweighing
-  IR sensors
-  Animal weighing
-  Differential weighing
-  ALIBI Memory

Paramètres Techniques

Paramètres métrologiques	
Capacité maximale [Max]	2 kg
Capacité minimale [Min]	-
Précision de lecture	0,01 g
Échelon de légalisation [e]	-
Étendue de tare	-2 kg
Répétabilité	0,03 g

Paramètres métrologiques	
Linéarité	±0,03 g
Temps de stabilisation	3 s
Ajustage	externe
Classe de précision OIML	-
Paramètres physiques	
Système de nivellement	manualny
Afficheur	5,7" Resistiv-Farb-Touchscreen
Dimension du plateau	195×195 mm
Dimensions de colis	530×310×150 mm
Masse nette	2,7 kg
Masse brute	4,22 kg
Construction	
Degré de protection	IP 43
Interface de Communication	
Interface de Communication	2×RS232, 2×USB-A, Ethernet, 4 IN / 4 OUT (digital), Wi-Fi
Paramètres électriques	
Alimentation	Adapter: 100 – 240V AC 50/60Hz 1A; 15V DC 2,4A Balance: 10 – 28V DC 1A max
Conditions environnementales	
Température du travail	+15 ÷ +30 °C
Température de stockage	-25 - +70 °C
Humidité relative d'air	10% ÷ 85% RH sans condensation

Répétabilité exprimée comme un écart standardisé de 10 placements de chargé.

Temps de stabilisation dépend de conditions externes et de la dynamique du placement d'un poids sur le plateau; déterminé pour le profil FAST.

* Wi-Fi® is a registered trademark of Wi-Fi® Alliance.



Accessoires

Tables antivibratoires
Lecteurs de cartes à transpondeur
Alimentateurs
Câbles RS 232 (balance – imprimante)
Câbles d'alimentation de cigare-allume
Lecteurs de code-barres
Câbles RS 232, RS 485
Imprimantes d'étiquettes
Modules complémentaires
Afficheurs

Câbles d'Entrées/ de Sorties
Claviers, manipulateurs
Supports, Statifs, bras-supports
Imprimante de tickets de caisse
Poids de classe F1 - cylindrique à bouton sans cavité d'ajustage, ensembles
Sorties de boucle de courant AP2-1
Câbles RS 232, RS 485
Modules de plateforme supplémentaires
Convertisseur RS 232 – USB
Câbles RS 232 (balance – imprimante)

Software

- E2R Pesages [WX-010-0099]
- E2R Registre [WX-010-0038]
- Audit Trail Reader [WX-010-0186]
- RADWAG Remote Desktop [WX-010-0107]
- Éditeur de Balances 2.1 [WX-010-0173]

- E2R Recettes [WX-010-0043]
- RAD Key [WX-010-0005]
- Éditeur D'étiquettes R02 [WX-010-0094]
- R-LAB [WX-010-0080]
- RADWAG Studio du Développement [WX-010-0104]

Dimensions d'appareil

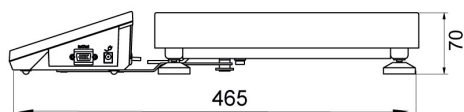

F1 version

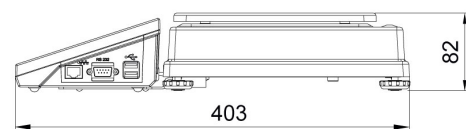
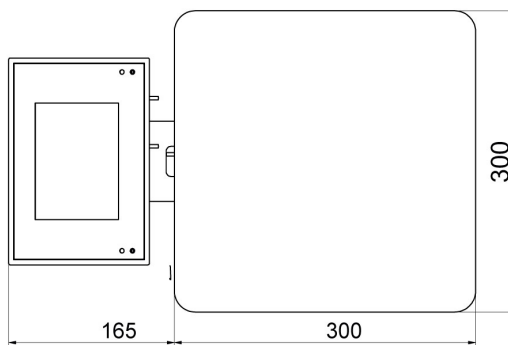

D2 version

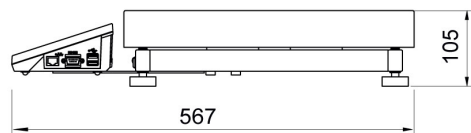
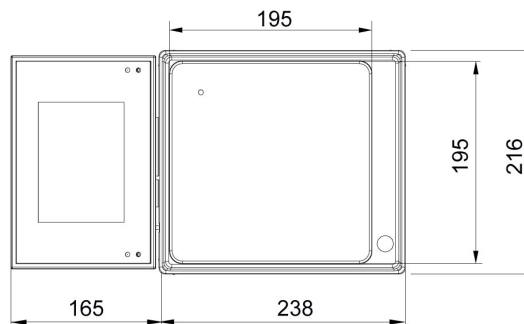

C2 version

