



More information on the website  
radwag.com/tr/info,w1,B08

# C315.30/60.C3.K Yük Hücreli Platform Terazi

WP-123-1025





The drawings, photos and graphics used are for illustrative purposes only.

## Fonksiyonlar

 Plus/Minus Control

 Percent Weighing

 Totalizing

 Parts counting

 Internal battery

 Peak hold

 Newton unit measurement

 GLP Procedures

 Animal weighing

 ALIBI Memory

## Teknik Veriler

Metrolojik parametreler	
Maksimum yük [Max]	30 / 60 kg
Minimum yük [Min]	200 g
Okuma için ruluęu [d]	10 / 20 g
Yasallařtırma birimi [e]	10 / 20 g
Dara aralıęı	-60 kg
OIML sınıfı	III

Fiziksel parametreler	
Display	LCD (aydınlatma ile)
Kablo uzunluğu	2,5 m
Tartım kefesi boyutları	500×700 mm
Ambalaj boyutları	730×800×270 mm
Net ağırlık	20,5 kg
Brüt ağırlık	26,8 kg
Konstrüksiyon	
IP Sınıfı	IP 65 konstrüksiyon, IP 43 terminal
Konstrüksiyon	toz kaplı çelik St3S
Tartım kefesi	Paslanmaz çelik AISI304
Haberleşme arayüzler	
Haberleşme arayüzü	RS232
Opsiyonel arayüzler	RS232
Elektrik parametreleri	
Güç kaynağı	100 – 240 V AC 50/60 Hz + batarya
Maksimum güç tüketimi	5 W
Batarya ile çalışma süresi	max 8h
Çevresel koşullar	
Çalıştırma sıcaklığı	-10 – +40 °C
Depolama sıcaklığı	-10 – +50 °C
Atmosferik nem	10% – 85% RH yoğunlaşma yok
İndikatör	C315



Additional fee for verification



## Aksesuarlar (Additional Fee)

Antivibrasyon masaları  
Güç adaptörü  
RS 232 cables (scale - printer)  
Tartım terminalleri için tutucular  
Çakmak prizine uygun besleme kabloları  
Display  
Display  
RS 232, RS 485 cables

RS 232 – Ethernet Converter  
AP2-1 Güç döngüsü çıkışı  
RS 232, RS 485 Kabloları  
RS 232 – USB Converter  
Kablolar RS 232 (Teraziler - Yazıcı)  
RS 232 – RS 485 Converter  
Fiş yazıcı

## Yazılım (Additional Fee)

• RAD Key [WX-010-0005]  
• R-Lab [WX-010-0080]

• R Panel [WX-010-0187]  
• Terazî Editörü - EWAG 2.1 [WX-010-0173]

## Cihaz boyutları



C315.C2.R



C315.C2.K



C315.C3.M

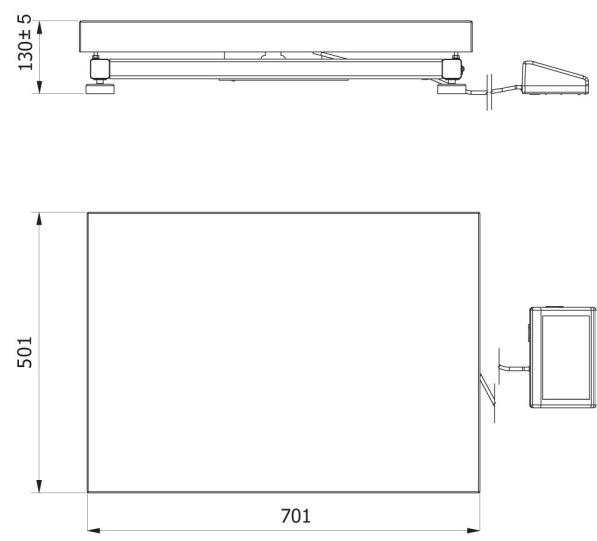

C315.C3.K