

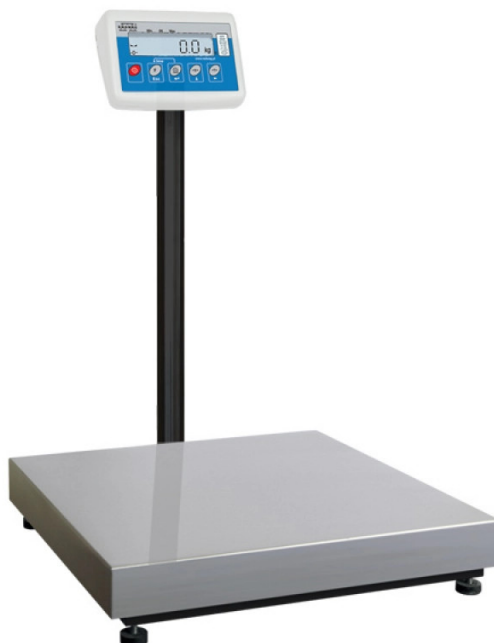

More information on the website
radwag.com/it/info,w1,BH9

Basamento a cella di carico C315.150.C3.M



The drawings, photos and graphics used are for illustrative purposes only.

Funzioni

 Plus/Minus Control

 Percent Weighing

 Totalizing

 Parts counting

 Internal battery

 Peak hold

 Newton unit measurement

 GLP Procedures

 Animal weighing

 ALIBI Memory

Specifiche

Parametri metrologici	
Portata massima [Max]	150 kg
Portata minima [Min]	1 kg
Divisione [d]	50 g
Intervallo di verifica della bilancia [e]	50 g
Campo di tara	-150 kg
Massima leggibilità per bilance non verificate	5 g
Classe OIML	III

Parametri fisici	
Display	LCD (backlit)
Dimensione piatto	500×700 mm
Dimensioni del pacco	730×800×270 mm
Peso netto	23,4 kg
Peso lordo	26 kg
Costruzione	
Punteggio IP	IP 65 construction, IP 43 terminal
Costruzione	mild steel St3S
Materiale da pesata	Stainless steel AISI304
Interfaccia di comunicazione	
Interfaccia	RS232
Interfacce opzionali	RS232
Parametri elettrici	
Alimentatore	100 – 240 V AC 50/60 Hz and battery
Massimo assorbimento elettrico	5 W
Tempo operativo delle batterie	max 8h
Environmental conditions	
Ambiente di lavoro	-10 ÷ +40 °C
Temperatura di stoccaggio	-10 ÷ +50 °C
Umidità relativa	10% ÷ 85% RH no condensation
Indicatore	C315



Extra payment for verification



Accessori

Alimentatore
 Cavo seriale RS 232 (connessione bilance - Stampanti)
 Cavo di alimentazione con spina per accendisigari
 Display
 Display
 Cavo seriale RS 232, RS 485
 Tavoli antivibranti
 RS 232 – Ethernet Converter

AP2-1 Power loop output
 Cavo seriale RS 232, RS 485
 RS 232 – USB Converter
 Cavo seriale RS 232 (connessione bilance - Stampanti)
 RS 232 – RS 485 Converter
 Stampanti di ricevuta
 Supporto, set di montaggio a muro e braccetti di montaggio

Software

- RAD Key [WX-010-0005]
- R-LAB [WX-010-0080]

- R Panel [WX-010-0187]
- Editore per sistemi di pesatura 2.1 [WX-010-0173]

Device dimensions

