



More information on the website
radwag.com/de/info,w1,A36

Waage mit hoher Auflösung HY10.1100.HRP.H.M2.2



The drawings, photos and graphics used are for illustrative purposes only.

Funktionen

-  Dosing
-  Labelling
-  Plus/Minus Control
-  Percent Weighing
-  Totalizing
-  Parts counting
-  Peak hold
-  Formulation
-  Newton unit measurement
-  Statistics
-  Checkweighing
-  GLP Procedures
-  Animal weighing
-  Differential weighing
-  Replaceable unit
-  SQC Statistical Quality Control
-  ALIBI Memory
-  Transactions

Technische Daten

| Messtechnische Parameter | |
|--------------------------|---------|
| Wägebereich [Max] | 1100 kg |
| Min. Belastung | 2500 g |
| Vorlast | 100 kg |
| Ziffernschritt [d] | 50 g |

| Messtechnische Parameter | |
|------------------------------|--|
| Eichwert [e] | 50 g |
| Tarierbereich | -1100 kg |
| Wiederholbarkeit | 15 g |
| Linearität | ±50 g |
| Stabilisierungszeit | 3 s |
| Justierung | intern (automatisch) |
| OIML-Klasse | II |
| Max. Anzahl der Eichwerte | 22000 e |
| Physikalische Parameter | |
| Display | 10,1" grafisch farbiger Touchscreen |
| Waagschale | 1000×800 mm |
| Verpackungsgröße | 1000×1200×666 mm |
| Nettogewicht | 126 kg |
| Bruttogewicht | 160 kg |
| Konstruktion | |
| Schutzart | IP 66 / 67 Konstruktion, IP 68 / 69 Messgerät |
| Konstruktion | Edelstahl AISI304 |
| Waageschale | Edelstahl AISI304 |
| Kommunikationsschnittstellen | |
| Schnittstellen | 2×RS232, 2×USB-A, Ethernet, 4 IN / 4 OUT (Digitalausgang) |
| Optionale Schnittstellen | Modul Wi-Fi 802.11 b/g/n, Modul Profibus (DP SLAVE), Modul RS485, Modul PROFINET (RJ45), Analogausgangsmodul (4-20mA, 0-20mA, 0-10V) , 12IN / 12OUT (IN – 5-24 VDC, OUT – max 30 VDC, 0,5 ADC) |
| Elektrische Parameter | |
| Stromversorgung | 100 – 240 V AC 50/60 Hz |
| Umgebungsbedingungen | |
| Umgebungstemperatur | +10 – +40 °C |
| Relative Luftfeuchtigkeit | 15% – 80% |

Wiederholbarkeit wird als Standardabweichung von 10 Wägezyklen ausgedrückt.

Relative Luftfeuchtigkeit unter nicht kondensierenden Bedingungen.

Stabilisierungszeit unter optimalen Umgebungsbedingungen.

* Wi-Fi® is a registered trademark of Wi-Fi® Alliance.



Extra payment for verification



Zubehör

Kabel RS 232 (Waage – Drucker)

Transponderkartenleser

Kabel RS 232 (Waage – Drucker ZEBRA)

Netzkabel (Waage – Ethernet)

Displays

Kabel RS 232, RS 485

E/A Kabel

Etikettendrucker

Wandhalterung, Stativ

Tastaturen, Taster

Thermische Drucker

USB-Kabel (Waage – Drucker)

Modul für zusätzliche Wägeplattformen

Zusätzliche Module

Software

- E2R Wägung [WX-010-0099]
- E2R Evidenz [WX-010-0038]
- Audit Trail Reader [WX-010-0186]
- Radweg Remote Desktop [WX-010-0107]
- Scale Editor 2.1 [WX-010-0173]
- E2R Rezepturen [WX-010-0043]
- RAD Key [WX-010-0005]
- Etiketten-Editor R02 [WX-010-0094]
- RLAB [WX-010-0080]
- RADWAG Development Studio [WX-010-0104]

Abmessungen des Geräts

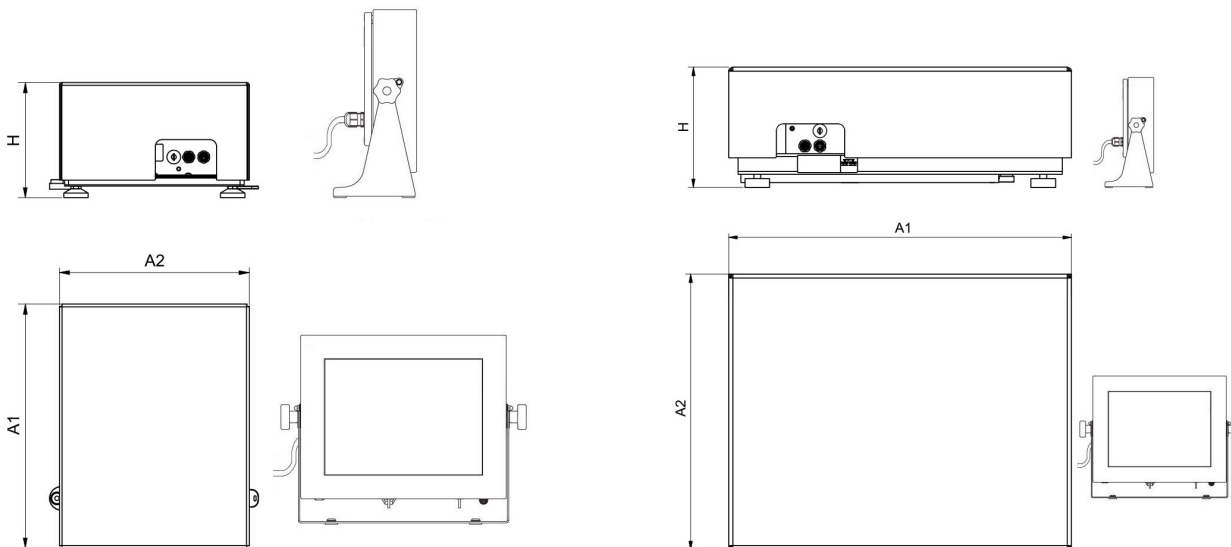

HY10.16 - 32.HRP.H

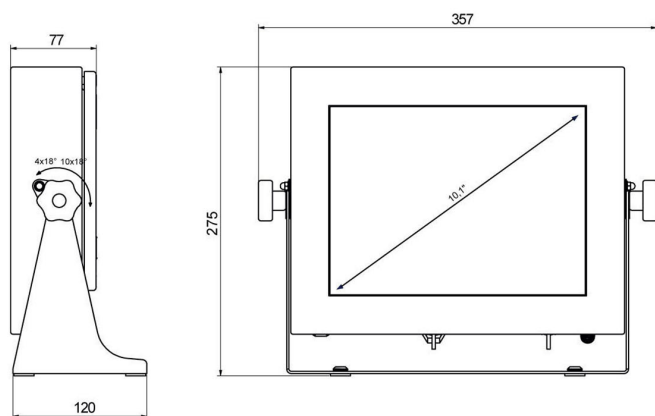

PUE HY10

| Scale type | A1 | A2 | H |
|-------------------------|------|------|-------|
| HY10.(16-32).HRP.H | 360 | 280 | 180±5 |
| HY10.(62-150).HRP.H | 500 | 400 | 180±5 |
| HY10.150.2.HRP.H | 500 | 500 | 180±5 |
| HY10.(150.1-300).HRP.H | 800 | 600 | 180±5 |
| HY10.(300.1-1100).HRP.H | 1000 | 800 | 180±5 |
| HY10.(2000).HRP.H | 1250 | 1000 | 180±5 |

Dimensions in mm