

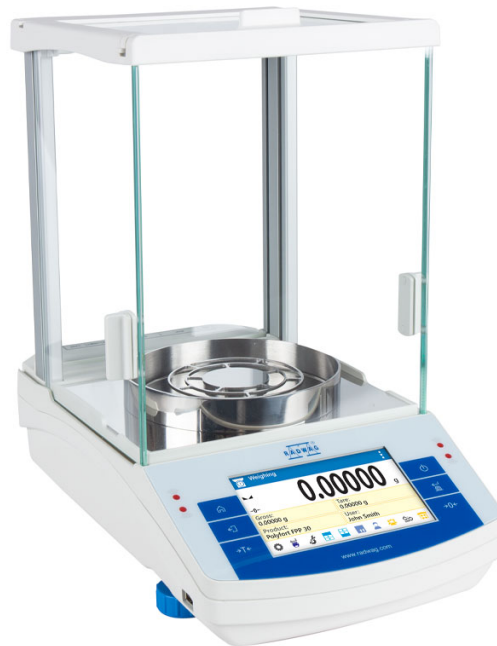





















More information on the website
radwag.com/us/info,w1,90N

AS 60/220.X2 PLUS Analytical Balance



The drawings, photos and graphics used are for illustrative purposes only.

Functions

-  Autotest
-  Dosing
-  Percent Weighing
-  Parts counting
-  Peak hold
-  Formulation
-  Newton unit measurement
-  Statistics
-  Checkweighing
-  IR sensors
-  Under-pan weighing
-  GLP Procedures
-  Animal weighing
-  Density determination
-  Ambient conditions monitoring
-  Replaceable unit
-  Statistical Quality Control
-  ALIBI Memory
-  Mass for titrator
-  Wi-Fi

Datasheet

Maximum capacity [Max]	60 / 220 g
Minimum load	1 mg
Readability [d]	0,01 / 0,1 mg
Verification unit [e]	1 mg

Tare range	-220 g
Standard repeatability [5% Max]	0,01 mg
Standard repeatability [Max]	0,06 mg
Standard minimum weight (USP)	20 mg
Standard minimum weight (U=1%, k=2)	2 mg
Permissible repeatability [5% Max]	0,02 mg
Permissible repeatability [Max]	0,1 mg
Linearity	±0,05/0,2 mg
Stabilization time	2 s
Adjustment	internal (automatic)
OIML Class	I
Physical parameters	
Leveling system	semi-automatic - LevelSENSING
Display	5" graphic color touchscreen
Weighing chamber doors	manual
Delivery components	Balance, weighing pan, weighing pan shield, centring ring, bottom cover, power supply, fabric dust cover.
Weighing chamber dimensions	190×190×222 mm
Weighing pan dimensions	ø90 open-work pan + ø85 (option) mm
Packaging dimensions	545×455×575 mm
Net weight	7,3 kg
Gross weight	10,5 kg
Construction	
Protection class	IP 43
Database capacity	7
Features of use	
Touch-free operation	2 IR Sensors
Communication interface	RS232 ¹ , 2×USB-A (interchangeable), USB-B, Wi-Fi, Ethernet
Power supply	Adapter: 100 – 240V AC 50/60Hz 0,6A; 12V DC 1,2A Balance: 12 – 15V DC 0,8A max
Power consumption max.	4 W
Operating temperature	+10 ÷ +40 °C
Ambient conditions monitoring (option)	THBR 2.0 System, THBR BOX, THB P, THB W, THB S
Relative humidity	40% ÷ 80%

* Wi-Fi® is a registered trademark of Wi-Fi® Alliance.



Extra payment for verification



Accessories

Antivibration tables
Holders for laboratory flasks
Power Adapters
Cigarette lighter receptacle power supply cables
Density determination KIT
USB cable (scale - printer)
Professional Weighing Tables
Barcode scanners
Holders for test tubes and filters
Workstation for pipettes calibration
RS 232, RS 485 cables

THBR 2.0 System - Ambient Conditions Monitoring
Displays
Protective cover for balances
Weighing dishes
Antistatic ionizer
Receipt Printer
RS 232, RS 485 cables
Additional modules
Under-pan weighing
RS 232 cables (scale - printer)
RS 232 – RS 485 Converter

Software

- RAD Key [WX-010-0005]
- Scale Editor - EWAG 2.1 [WX-010-0173]

- Alibi Reader PC Software [WX-010-0114]
- RADWAG Development Studio [WX-010-0104]

Device dimensions

AS X2 PLUS, d = 0.01 mg

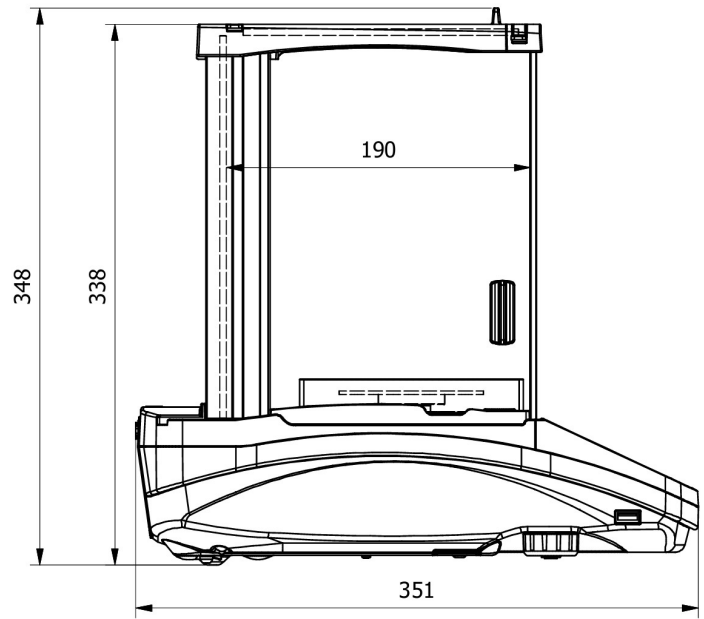

AS X2 PLUS, d = 0.1 mg

