

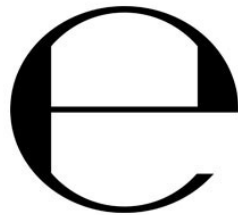

















More information on the website  
radwag.com/it/info,w1,9N1

# Bilancia WLY 6/12.F1.R.CPC



The drawings, photos and graphics used are for illustrative purposes only.

## Funzioni

-  Dosing
-  Labelling
-  Plus/Minus Control
-  Percent Weighing
-  Totalizing
-  Parts counting
-  Peak hold
-  Formulation
-  Newton unit measurement
-  Statistics
-  Checkweighing
-  IR sensors
-  Animal weighing
-  Differential weighing
-  Packaged Goods Control
-  ALIBI Memory

## Specifiche

Parametri metrologici	
Portata massima [Max]	6 / 12 kg
Portata minima [Min]	50 g
Divisione [d]	1 / 2 g
Intervallo di verifica della bilancia [e]	1 / 2 g
Campo di tara	-12 kg
Ripetibilita	1 / 2 g

Parametri metrologici	
Linearità	±1 / 2 g
Tempo di stabilizzazione	3 s
Calibrazione	external
Classe OIML	II
Parametri fisici	
Sistema di livellamento	manual
Display	5,7" Resistive Color Touchscreen
Dimensione piatto	300×300 mm
Dimensioni del pacco	570×390×170 mm
Peso netto	5,2 kg
Peso lordo	6,5 kg
Costruzione	
Punteggio IP	IP 43
Interfaccia di comunicazione	
Interfaccia	2×RS232, 2×USB-A, Ethernet, 4 IN / 4 OUT (digital), Wi-Fi
Parametri elettrici	
Alimentatore	Adapter: 100 – 240V AC 50/60Hz 1A; 15V DC 2,4A Balance: 10 – 28V DC 1A max
Environmental conditions	
Ambiente di lavoro	+15 – +30 °C
Temperatura di stoccaggio	-25 – +70 °C
Umidità relativa	10% – 85% RH no condensation

\* Wi-Fi® is a registered trademark of Wi-Fi® Alliance.



## Accessori

Lettore di tessere transponder  
 Alimentatore  
 Cavo seriale RS 232 (connessione bilance - Stampanti)  
 Cavo di alimentazione con spina per accendisigari  
 Lettore di codici a barre  
 Pesatura sottopensile  
 Cavo seriale RS 232, RS 485  
 stampanti per etichette  
 Moduli aggiuntivi  
 Display

cavi IN/OUT  
 Tastiera, interruttori esterni  
 Supporto, set di montaggio a muro e braccetti di montaggio  
 Stampanti di ricevuata  
 Pesi standard F1 - cilindrici, set  
 AP2-1 Power loop output  
 Cavo seriale RS 232, RS 485  
 Moduli aggiuntivi della piattaforma  
 RS 232 – USB Converter  
 Cavo seriale RS 232 (connessione bilance - Stampanti)

## Software

- E2R Weighing [WX-010-0099]
- E2R Weighing Records [WX-010-0038]
- Audit Trail Reader [WX-010-0186]
- RADWAG Remote Desktop [WX-010-0107]

- E2R PGC [WX-010-0051]
- RAD Key [WX-010-0005]
- Editore di etichette R02 [WX-010-0094]
- R-LAB [WX-010-0080]

## Device dimensions

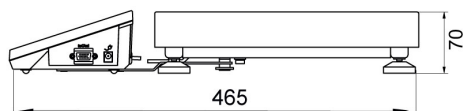

F1 version

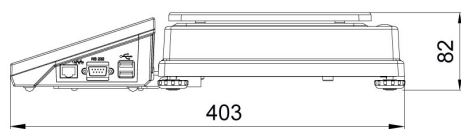
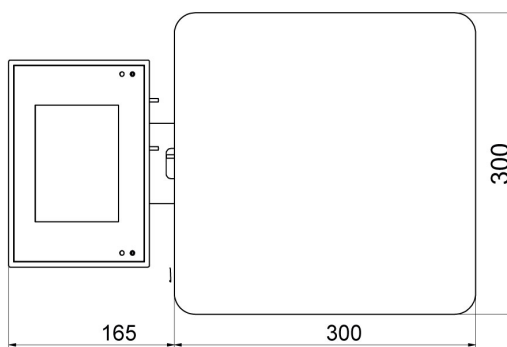

D2 version

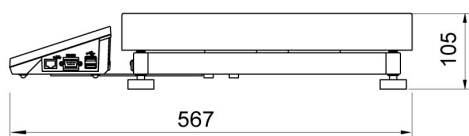
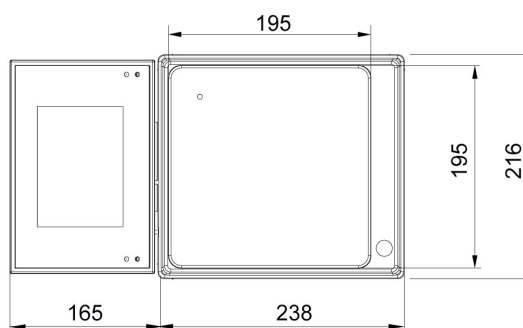

C2 version

