

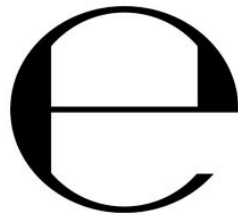

More information on the website
radwag.com/de/info,w1,9N1

















Waage WLY 6/12.F1.R.FPVO

WK-307-1042



The drawings, photos and graphics used are for illustrative purposes only.

Funktionen

-  Dosing
-  Labelling
-  Plus/Minus Control
-  Percent Weighing
-  Totalizing
-  Parts counting
-  Peak hold
-  Formulation
-  Newton unit measurement
-  Statistics
-  Checkweighing
-  IR sensors
-  Animal weighing
-  Differential weighing
-  Packaged Goods Control
-  ALIBI Memory

Technische Daten

Messtechnische Parameter	
Wägebereich [Max]	6 / 12 kg
Min. Belastung	50 g
Zifferschritt [d]	1 / 2 g
Eichwert [e]	1 / 2 g
Tarierbereich	-12 kg
Wiederholbarkeit	1 / 2 g

Messtechnische Parameter	
Linearität	±1 / 2 g
Stabilisierungszeit	3 s
Justierung	extern
OIML-Klasse	II
Physikalische Parameter	
Nivelliersystem	manuell
Display	5,7" Resistiv-Farb-Touchscreen
Waagschale	300×300 mm
Verpackungsgröße	570×390×170 mm
Nettogewicht	5,2 kg
Bruttogewicht	6,5 kg
Konstruktion	
Schutzart	IP 65 Konstruktion, IP 43 Terminal
Kommunikationsschnittstellen	
Schnittstellen	2×RS232, 2×USB-A, Ethernet, 4 IN / 4 OUT (Digitalausgang), Wi-Fi
Elektrische Parameter	
Stromversorgung	Adapter: 100 – 240V AC 50/60Hz 1A; 15V DC 2,4A Waage: 10 – 28V DC 1A max
Umgebungsbedingungen	
Umgebungstemperatur	+15 – +30 °C
Lagertemperatur	-25 – +70 °C
Relative Luftfeuchtigkeit	10% – 85% RH ohne Kondensation

* Wi-Fi® is a registered trademark of Wi-Fi® Alliance.



Zubehör (Additional Fee)

Transponderkartenleser
Netzteile
Kabel RS 232 (Waage – Drucker)
Anschlusskabel für Zigarettenanzünder
Barcode-Scanner
Unterflurwägung
Kabel RS 232, RS 485
Etikettendrucker
Zusätzliche Module
Displays

E/A Kabel
Tastaturen, Taster
Wandhalterung, Stativ
Thermische Drucker
Prüfgewichte der F1 Klasse - Knopfgewichte, Sätze
Ausgang der Stromschnittstelle AP2-1
Kabel RS 232, RS 485
Modul für zusätzliche Wägeplattformen
Konverter RS 232 – USB
Kabel RS 232 (Waage – Drucker)

Software (Additional Fee)

- E2R Wägung [WX-010-0099]
- E2R Evidenz [WX-010-0038]
- Audit Trail Reader [WX-010-0186]
- Radwag Remote Desktop [WX-010-0107]

- E2R FPVO [WX-010-0051]
- RAD Key [WX-010-0005]
- Etiketten-Editor R02 [WX-010-0094]
- RLAB [WX-010-0080]

Abmessungen des Geräts

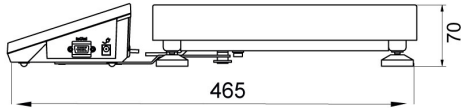

F1 version

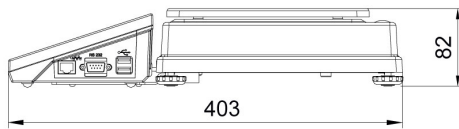
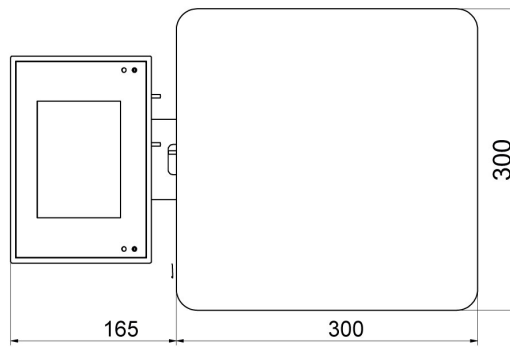

D2 version

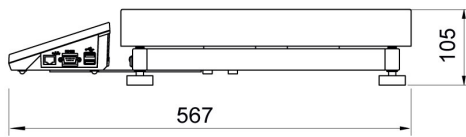
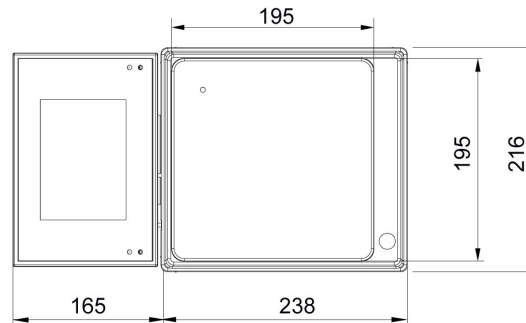

C2 version

