

















More information on the website  
[radwag.com/it/info,w1,97Q](http://radwag.com/it/info,w1,97Q)

# Bilancia multifunzione WPY 1,5/F1



The drawings, photos and graphics used are for illustrative purposes only.

## Funzioni

-  Dosing
-  Labelling
-  Plus/Minus Control
-  Percent Weighing
-  Totalizing
-  Parts counting
-  Peak hold
-  Formulation
-  Newton unit measurement
-  Statistics
-  Checkweighing
-  IR sensors
-  Animal weighing
-  Differential weighing
-  ALIBI Memory

## Specifiche

Parametri metrologici	
Portata massima [Max]	1,5 kg
Portata minima [Min]	10 g
Divisione [d]	0,5 g
Campo di tara	-1,5 kg
Massima leggibilità per bilance non verificate	0,2 g
Tempo di stabilizzazione	2 s

Parametri metrologici	
Calibrazione	external
Classe OIML	III
Parametri fisici	
Display	5,7" Resistive Color Touchscreen
Dimensione piatto	300×300 mm
Dimensioni del pacco	570×390×170 mm
Peso netto	5,3 kg
Peso lordo	6,1 kg
Costruzione	
Punteggio IP	IP 43
Interfaccia di comunicazione	
Interfaccia	2×RS232, 2×USB-A, Ethernet, 4 IN / 4 OUT (digital), Wi-Fi
Parametri elettrici	
Alimentatore	100 – 240 V AC 50/60 Hz
Environmental conditions	
Ambiente di lavoro	-10 ÷ +40 °C

\* Wi-Fi® is a registered trademark of Wi-Fi® Alliance.



Extra payment for verification



## Accessori

Tavoli antivibranti

Lettore di tessere transponder

Cavo seriale RS 232 (connessione bilance - Stampanti)

Cavo di alimentazione con spina per accendisigari

Lettore di codici a barre

Cavo seriale RS 232, RS 485

stampanti per etichette

Display

cavi IN/OUT

Tastiera, interruttori esterni

Supporto, set di montaggio a muro e braccetti di montaggio

Stampanti di ricevuta

Pesi standard F1 - cilindrici, set

AP2-1 Power loop output

Cavo seriale RS 232, RS 485

Moduli aggiuntivi della piattaforma

RS 232 – USB Converter

Cavo seriale RS 232 (connessione bilance - Stampanti)

## Software

• E2R Weighing [WX-010-0099]

• E2R PGC [WX-010-0051]

• RAD Key [WX-010-0005]

• Editore di etichette R02 [WX-010-0094]

• R-LAB [WX-010-0080]

• Software „Development Studio” RADWAG [WX-010-0104]

• E2R Formulazione [WX-010-0043]

• E2R Weighing Records [WX-010-0038]

• Audit Trail Reader [WX-010-0186]

• RADWAG Remote Desktop [WX-010-0107]

• Editore per sistemi di pesatura 2.1 [WX-010-0173]

## Device dimensions

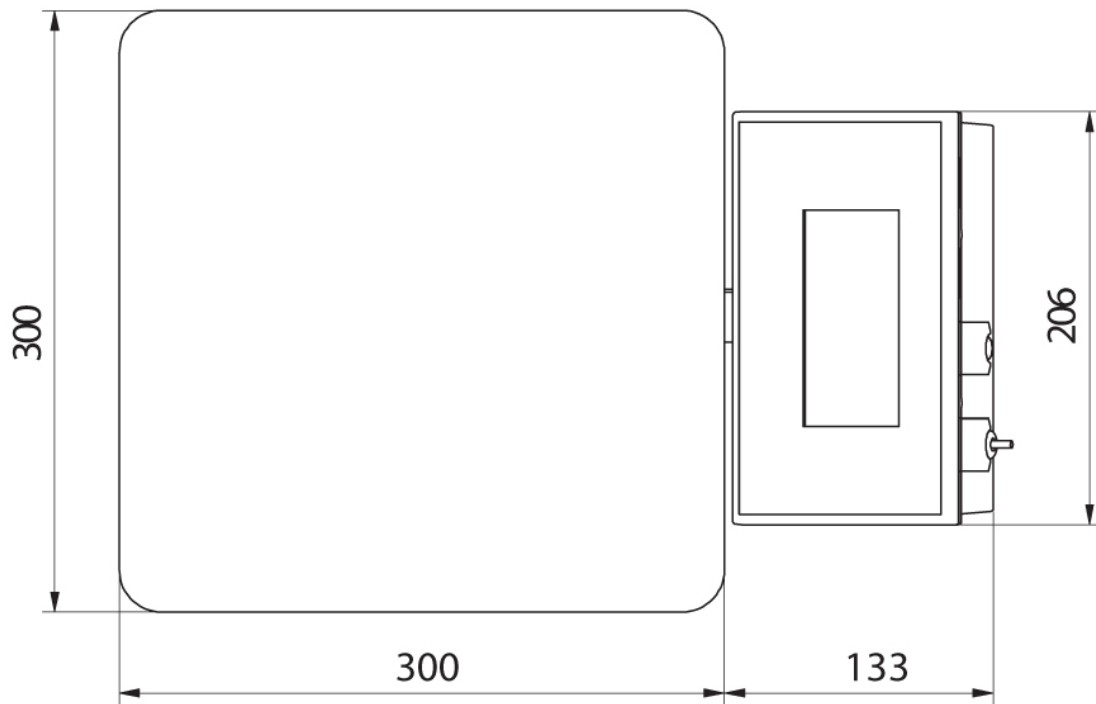
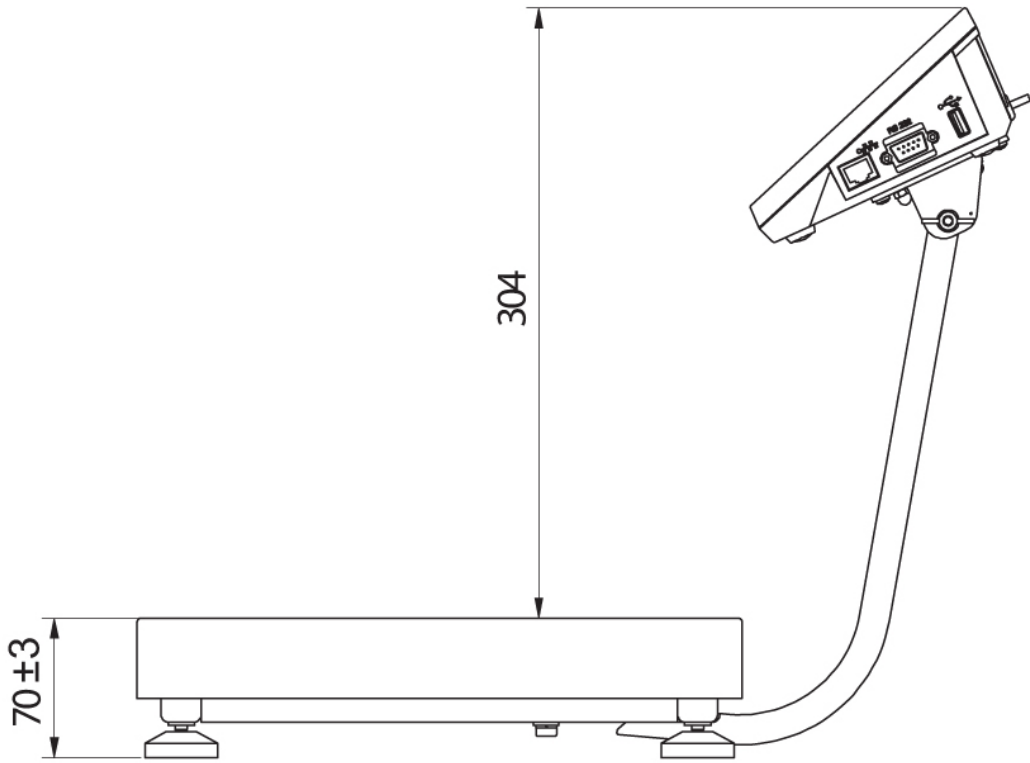

WPY F1/M

---