



C32.6.F1.R Multifunctional Scale

WP-120-0010

More information on the website
radwag.com/en/info,w1,8X0



The drawings, photos and graphics used are for illustrative purposes only.

Functions



Labelling



Plus/Minus Control



Percent Weighing



Totalizing



Parts counting



Newton unit measurement



Statistics



IR sensors



GLP Procedures



Replaceable unit



ALIBI Memory

Datasheet

Metrological parameters	
Maximum capacity [Max]	6 kg
Minimum load	40 g
Readability [d]	2 g
Verification unit [e]	2 g
Tare range	-6 kg
Max readability for non-verified scale	0.2 g
OIML Class	III

Physical parameters	
Leveling system	manual
Display	5" graphic colour
Weighing pan dimensions	300×300 mm
Packaging dimensions W x D x H	570×390×170 mm
Net weight	5.3 kg
Gross weight	6.1 kg
Construction	
Protection class	IP 65 construction, IP 43 terminal
Construction	mild steel St3S
Weighing pan material	Stainless steel AISI304
Communication interface	
Communication interface	2×RS232, USB-A, USB-B, Ethernet, 4 IN / 4 OUT (digital), Wi-Fi
Electrical parameters	
Power supply	100 – 240 V AC 50/60 Hz
Power consumption max.	10 W
Optional power supply	internal rechargeable battery
Operation time on batteries	operation time up to 5 h
Environmental conditions	
Operating temperature	-10 – +40 °C

* Optional equipment at additional cost

* Wi-Fi® is a registered trademark of Wi-Fi® Alliance.



Additional fee for verification



Accessories (Additional Fee)

Displays

Power Adapters

RS 232 cables (scale - printer)

Cigarette lighter receptacle power supply cables

Barcode scanners

RS 232, RS 485 cables

Label Printers

Antivibration Tables

Keypad, external switches

Stands, wall mounting kits and mounting brackets

Additional modules

Receipt Printer

AP2-1 Current Loop Unit

Software (Additional Fee)

• E2R Weighing [WX-010-0099]

• Label Editor R02 [WX-010-0094]

• R-Lab [WX-010-0080]

• RADWAG Development Studio [WX-010-0104]

• RAD Key [WX-010-0005]

• Alibi Reader [WX-010-0114]

• Scale Editor 2.1 [WX-010-0173]

Device dimensions W x D x H

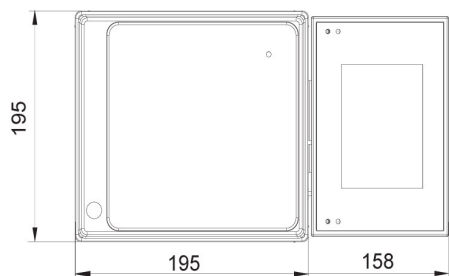

C32.D2

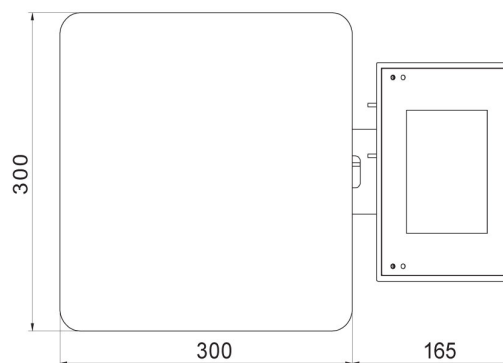
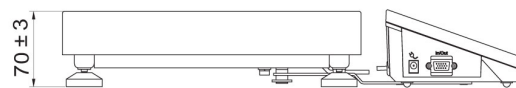

C32.F1.R

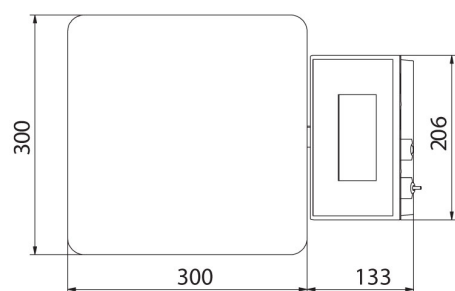
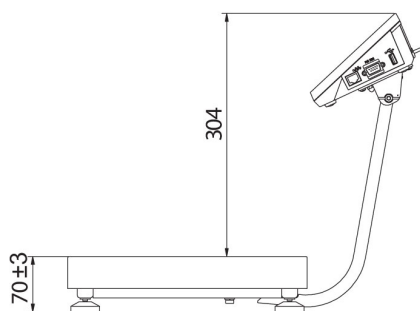

C32.F1.M

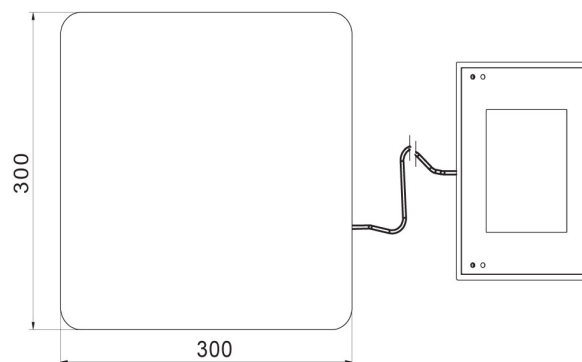
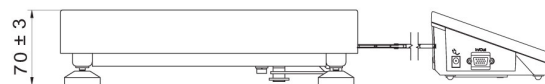

C32.F1.K