























More information on the website
radwag.com/de/info,w1,8WO

Präzisionswaage WLC 6.X7



The drawings, photos and graphics used are for illustrative purposes only.

Funktionen

-  Autotest
-  Dosing
-  Percent Weighing
-  Parts counting
-  Peak hold
-  Formulation
-  Newton unit measurement
-  Statistics
-  Checkweighing
-  IR sensors
-  Under-pan weighing
-  GLP Procedures
-  Animal weighing
-  Density determination
-  Ambient conditions monitoring
-  Replaceable unit
-  Statistical Quality Control
-  ALIBI Memory
-  Mass for titrator
-  Wi-Fi

Technische Daten

Messtechnische Parameter	
Wägebereich [Max]	6 kg
Zifferschritt [d]	0,1 g
Eichwert [e]	-
Tarierbereich	-6 kg

Messtechnische Parameter	
Wiederholbarkeit	0,1 g
Linearität	±0,3 g
Stabilisierungszeit	2 s
Justierung	intern (automatisch)
Physikalische Parameter	
Nivelliersystem	manualny
Display	7" grafisch farbiger Touch-Screen
Waagschale	195×195 mm
Verpackungsgröße	430×270×190 mm
Nettogewicht	2,2 kg
Bruttogewicht	4 kg
Konstruktion	
Schutzart	IP 43
Komponenten und Software	
Datenbankkapazität	7
Kommunikationsschnittstellen	
Schnittstellen	2×RS232 ¹ , USB-A, USB-B, Ethernet, Wi-Fi
Elektrische Parameter	
Stromversorgung	Adapter: 100 – 240V AC 50/60Hz 0,6A; 12V DC 1,2A Waage: 10 – 15VDC 0,6A max
Umgebungsbedingungen	
Umgebungstemperatur	+10 ÷ +40 °C

Wiederholbarkeit wird als Standardabweichung von 10 Wägezyklen ausgedrückt.

Die Stabilisierungszeit ist abhängig von den Umgebungsbedingungen und der Geschwindigkeit bei Auflegen der Last auf der Waagschale; für FAST-Profil definiert.

¹ Barcode scanners, available as weighing instrument accessory, communicate with the instrument via RS232 interface exclusively.

* Wi-Fi® is a registered trademark of Wi-Fi® Alliance.



Zubehör

Waagenkoffer
 Antivibrationstische
 Netzteile
 Kabel RS 232 (Waage – Drucker)
 Anschlusskabel für Zigarettensanzünder
 USB-Kabel (Waage – Drucker)
 Barcodescanner
 Unterflurwägung

Kabel RS 232, RS 485
 Dichtebestimmungsset
 Displays
 Thermische Drucker
 Kabel RS 232, RS 485
 Schutzhauben
 Kabel RS 232 (Waage – Drucker)
 Konverter RS 232 – RS 485

Software

• RAD Key [WX-010-0005]

• Alibi Reader [WX-010-0114]

Abmessungen des Geräts

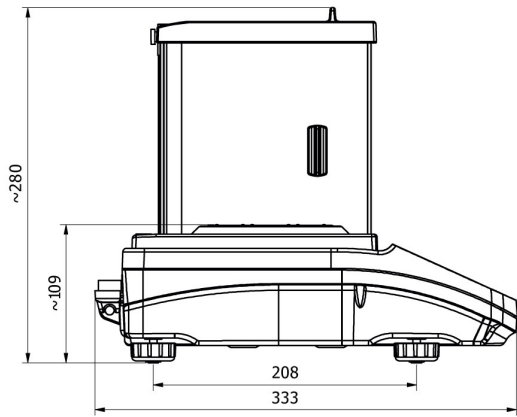

WLC X2, d = 0.001 mg

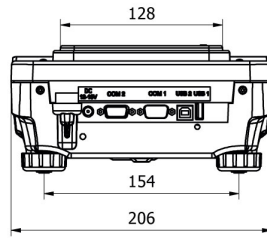
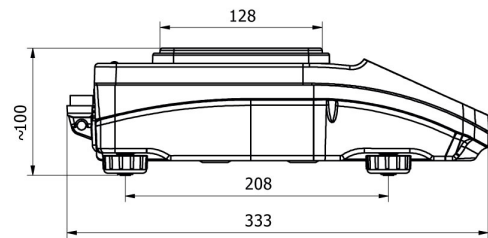
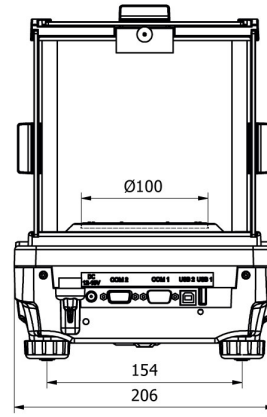

WLC X2, d = 0.01 mg

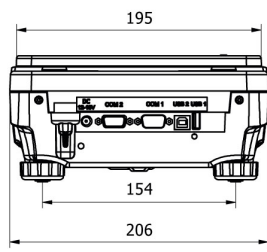
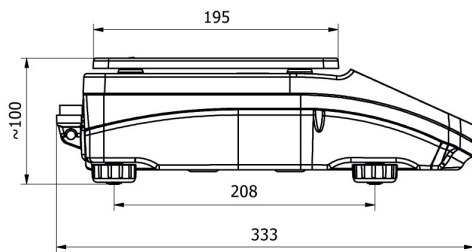

WLC X2, d = 0.1 mg