

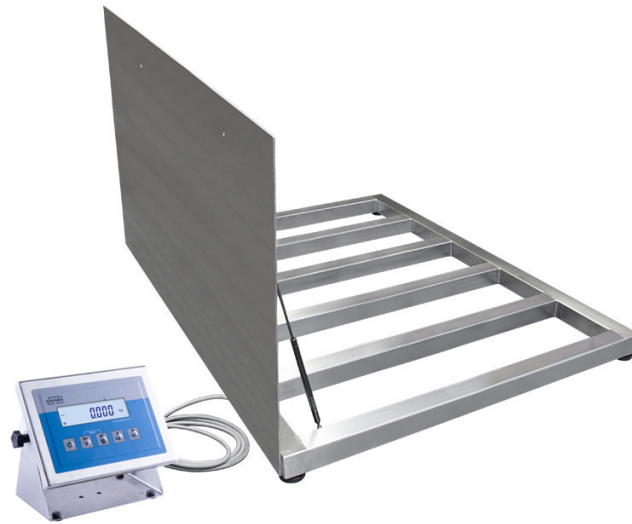

More information on the website
radwag.com/it/info,w1,8LG

Basamento in acciaio inox con apertura a compasso H315.4.150.H7/Z



The drawings, photos and graphics used are for illustrative purposes only.

Funzioni

 Plus/Minus Control

 Percent Weighing

 Totalizing

 Parts counting

 Internal battery

 Peak hold

 Newton unit measurement

 Animal weighing

Specifiche

Parametri metrologici

Portata massima [Max]	150 kg
Portata minima [Min]	1 kg
Divisione [d]	50 g
Campo di tara	-150 kg
Massima leggibilità per bilance non verificate	20 g
Classe OIML	III

Parametri fisici

Display	LCD (backlit)
Lunghezza del cavo	3 m

Parametri fisici	
Dimensione piatto	1000×1000 mm
Altezza della piattaforma	88 mm
Dimensioni del pacco	1200×1200×530 mm
Mass scala con indicatore e telaio	105 kg
Costruzione	
Punteggio IP	IP 68 construction, IP 68 (1h max)/69 terminal
Interfaccia di comunicazione	
Interfaccia	RS232, USB
Interfacce opzionali	RS232 or RS485 or 4IN/4OUT or Ethernet or analog output 4-20 mA
Parametri elettrici	
Alimentatore	100 – 240 V AC 50/60 Hz
Alimentatore opzionale	internal rechargeable battery
Tempo operativo delle batterie	max 7h
Environmental conditions	
Ambiente di lavoro	-10 – +40 °C
Umidità relativa	10% – 85% RH no condensation



Extra payment for verification



Accessori

Cavo seriale RS 232 (connessione bilance - Stampanti)
 Display
 Cavo seriale RS 232 (connessione bilance - Ethernet)
 Cavo seriale RS 232, RS 485
 RS 232 – Ethernet Converter
 USB adatper

Stampanti di ricevuta
 cavo USB (connessione bilance - stampanti)
 Supporto, set di montaggio a muro e braccetti di montaggio
 RS 232 – USB Converter
 Cavo seriale RS 232, RS 485

Software

- RAD Key [WX-010-0005]
- R-LAB [WX-010-0080]

- R Panel [WX-010-0187]
- Editore per sistemi di pesatura 2.1 [WX-010-0173]

Device dimensions



Single-leaf platform:

H315.4.H6/Z

H315.4.H7/Z

H315.4.H8/Z

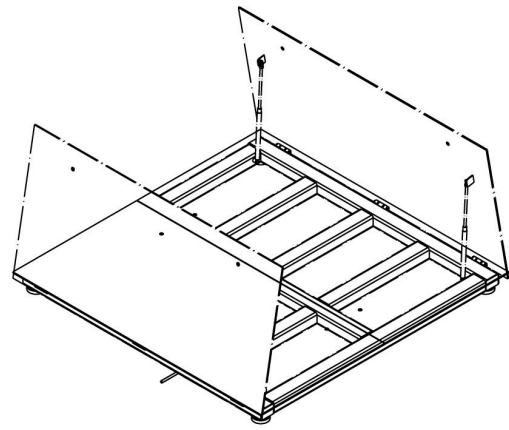

Double-leaf platform:

H315.4.H8/9/Z

H315.4.H9/Z

H315.4.H10/Z

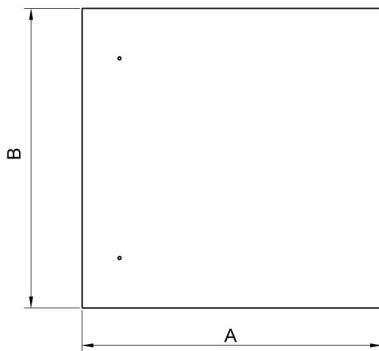
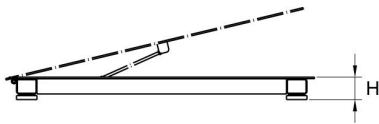

Scale type	A	B	H
H315.4.150-600.H6/Z	800	800	88±2
H315.4.150-1500.H7/Z	1000	1000	88±2
H315.4.300-1500.H8/Z	1200	1200	88 ±2
H315.4.3000.H8/Z	1200	1200	111 ±2
H315.4.300-1500.H8/9/Z	1200	1500	88 ±2
H315.4.3000.H8/9/Z	1200	1500	111 ±2
H315.4.300-1500.H9/Z	1500	1500	88 ±2
H315.4.3000-6000.H9/Z	1500	1500	111 ±2
H315.4.600-6000.H10/Z	1500	2000	111 ±2

dimensions in mm