



More information on the website
radwag.com/es/info,w1,866

Rampa de balanza H6 600kg



The drawings, photos and graphics used are for illustrative purposes only.

Datos técnicos

Construcción	
Material	Acero inoxidable
Parámetros físicos	
Dimensión de plataforma de carga	800×1150 mm



Trabaja con

Báscula de plataforma inoxidable H315 4H

Báscula multifuncional de plataforma inoxidable HX7.4 H

Dimensiones de aparato

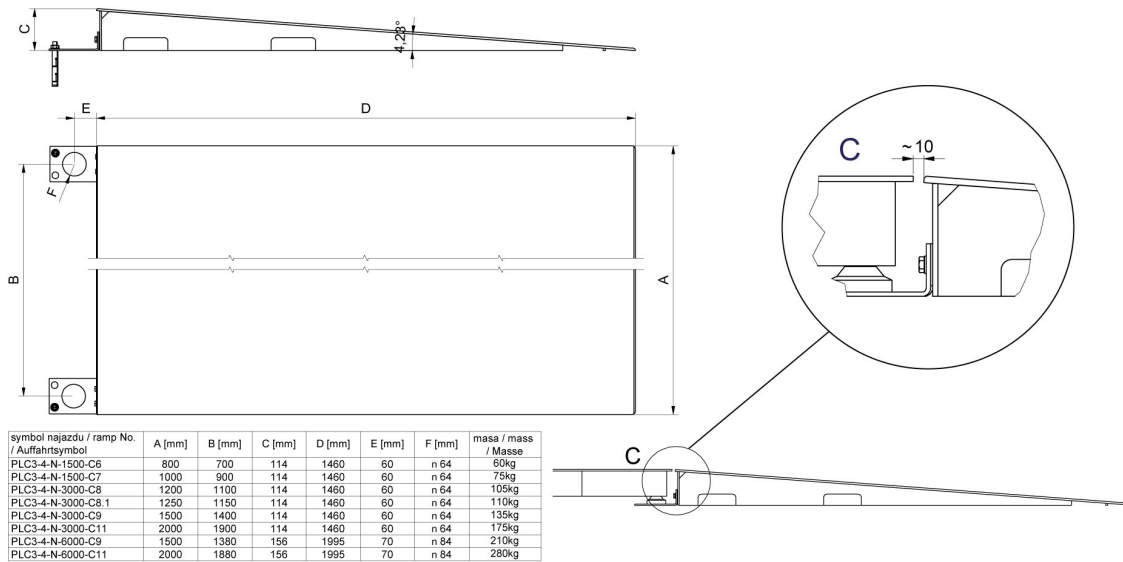

Ramps made of powder-coated steel

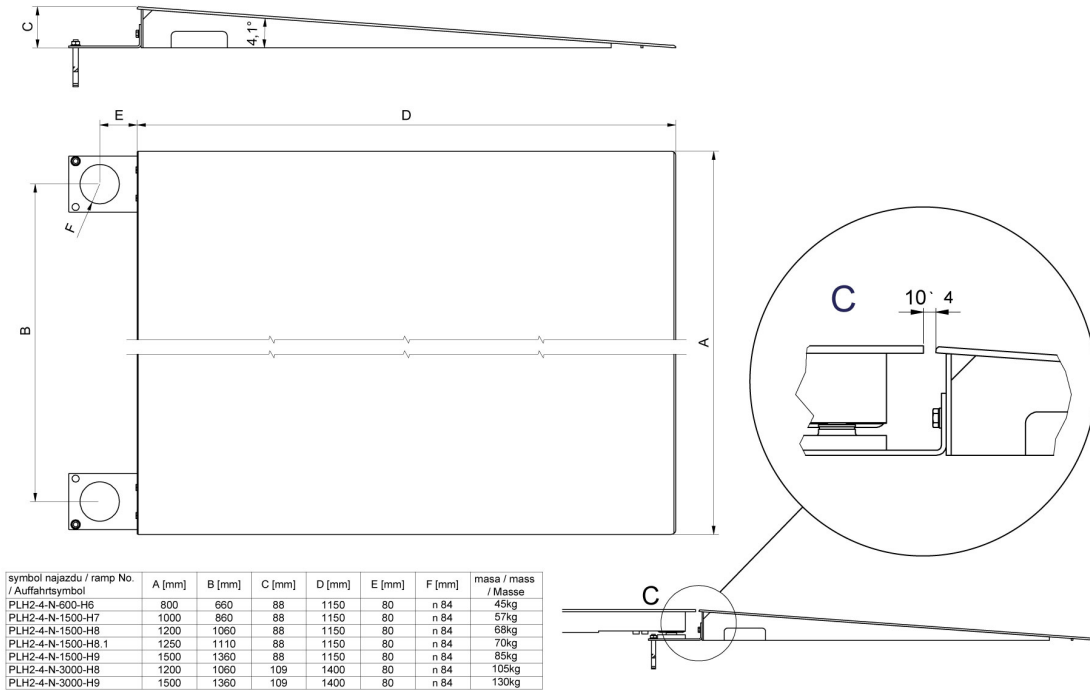

Ramps made of stainless steel