



More information on the website
radwag.com/it/info,w1,7MZ

Bilancia pesa pallet in acciaio inox H315.4P.600.H





The drawings, photos and graphics used are for illustrative purposes only.

Funzioni

 Plus/Minus Control

 Percent Weighing

 Totalizing

 Parts counting

 Internal battery

 Peak hold

 Newton unit measurement

 Animal weighing

Specifiche

Parametri metrologici	
Portata massima [Max]	600 kg
Portata minima [Min]	4 kg
Divisione [d]	200 g
Campo di tara	-600 kg
Massima leggibilità per bilance non verificate	200 g
Classe OIML	III
Parametri fisici	
Display	LCD (backlit)
Lunghezza del cavo	3 m

Parametri fisici	
Dimensione piatto	860×1200 mm
Device dimensions	1330×860×80 mm
Dimensioni del pacco	1400×900×430 mm
Mass scala con indicatore	46 kg
Costruzione	
Punteggio IP	IP 68 construction, IP 68 (1h max)/69 terminal
Interfaccia di comunicazione	
Interfaccia	RS232, USB
Interfacce opzionali	RS232 or RS485 or 4IN/4OUT or Ethernet or analog output 4-20 mA
Parametri elettrici	
Alimentatore	100 – 240 V AC 50/60 Hz
Alimentatore opzionale	internal rechargeable battery
Tempo operativo delle batterie	max 7h
Environmental conditions	
Ambiente di lavoro	-10 – +40 °C
Umidità relativa	10% – 85% RH no condensation



Extra payment for verification



Accessori

Cavo seriale RS 232 (connessione bilance - Stampanti)
 Display
 Cavo seriale RS 232 (connessione bilance - Ethernet)
 Cavo seriale RS 232, RS 485
 RS 232 – Ethernet Converter
 USB adapter

Stampanti di ricevuta
 cavo USB (connessione bilance - stampanti)
 Supporto, set di montaggio a muro e braccetti di montaggio
 RS 232 – USB Converter
 Cavo seriale RS 232, RS 485

Software

- RAD Key [WX-010-0005]
- R-LAB [WX-010-0080]

- R Panel [WX-010-0187]
- Editore per sistemi di pesatura 2.1 [WX-010-0173]

Device dimensions

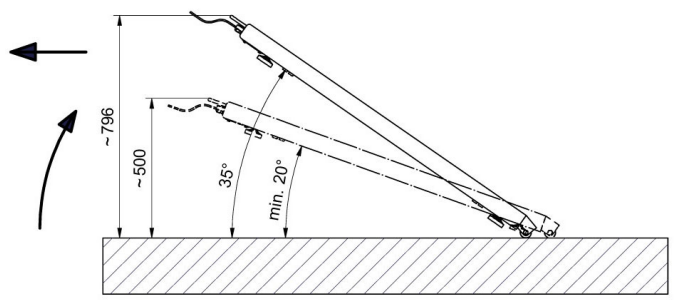
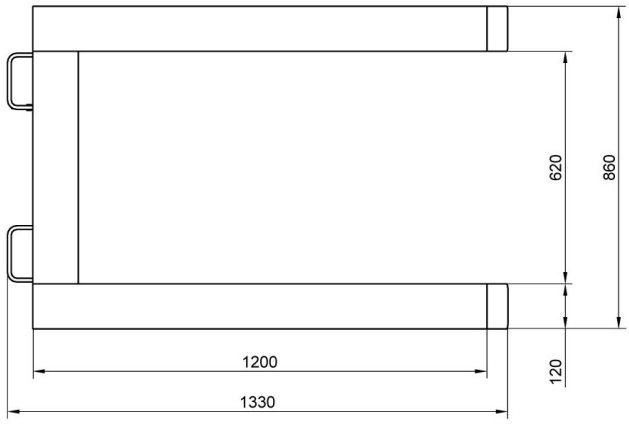
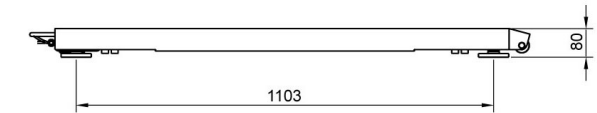

Transport of the pallet scale using casters and handles.