



More information on the website  
[radwag.com/de/info,w1,7K3](https://radwag.com/de/info,w1,7K3)

# Bodeneinbauwaage H315.4.300/600.H7/Z



The drawings, photos and graphics used are for illustrative purposes only.

## Funktionen

 Plus/Minus Control

 Percent Weighing

 Totalizing

 Parts counting

 Internal battery

 Peak hold

 Newton unit measurement

 Animal weighing

## Technische Daten

Messtechnische Parameter	
Wägebereich [Max]	300/600 kg
Min. Belastung	2 kg
Zifferschritt [d]	100/200 g
Tarierbereich	-600 kg
OIML-Klasse	III
Physikalische Parameter	
Display	LCD (hinterleuchtet)
Waagschale	1000×1000 mm
Höhe Wägeplattform	88 mm

Physikalische Parameter	
Verpackungsgröße	1200×1200×530 mm
Gewicht der Waage mit Messgerät und Rahmen	105 kg
Kabellänge	3 m
Konstruktion	
Schutzart	IP 68 Konstruktion, IP 68 (1h max)/69 Messgerät
Kommunikationsschnittstellen	
Schnittstellen	RS232, USB
Optionale Schnittstellen	RS232 oder RS485 oder 4IN/4OUT oder Ethernet oder analog output 4-20 mA
Elektrische Parameter	
Stromversorgung	100 – 240 V AC 50/60 Hz
Optionale Stromversorgung	interner Akkumulator
Akku-Betriebszeit	max 7h
Umgebungsbedingungen	
Umgebungstemperatur	-10 ÷ +40 °C
Relative Luftfeuchtigkeit	10% ÷ 85% RH ohne Kondensation



Extra payment for verification



## Zubehör

Kabel RS 232 (Waage – Drucker)  
 Displays  
 Netzkabel (Waage – Ethernet)  
 Kabel RS 232, RS 485  
 Konverter RS 232 – Ethernet  
 USB-Adapter

Thermische Drucker  
 USB-Kabel (Waage – Drucker)  
 Stative, Ausleger  
 Konverter RS 232 – USB  
 Kabel RS 232, RS 485

## Software

- RAD Key [WX-010-0005]
- RLAB [WX-010-0080]

- R Panel [WX-010-0187]
- Scale Editor 2.1 [WX-010-0173]

## Abmessungen des Geräts



Single-leaf platform:  
H315.4.H6/Z  
H315.4.H7/Z  
H315.4.H8/Z

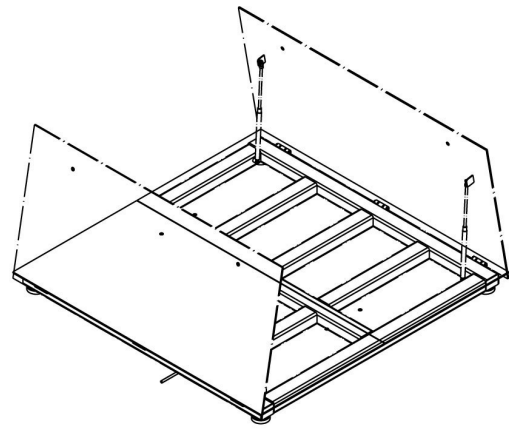

Double-leaf platform:  
H315.4.H8/9/Z  
H315.4.H9/Z  
H315.4.H10/Z

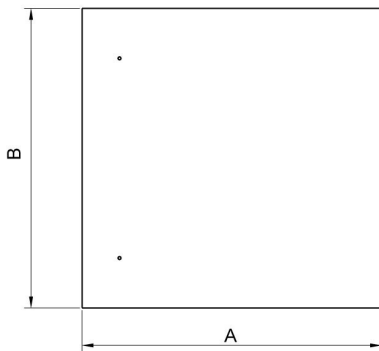
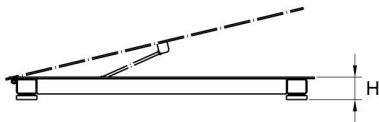

Scale type	A	B	H
H315.4.150-600.H6/Z	800	800	88±2
H315.4.150-1500.H7/Z	1000	1000	88±2
H315.4.300-1500.H8/Z	1200	1200	88 ±2
H315.4.3000.H8/Z	1200	1200	111 ±2
H315.4.300-1500.H8/9/Z	1200	1500	88 ±2
H315.4.3000.H8/9/Z	1200	1500	111 ±2
H315.4.300-1500.H9/Z	1500	1500	88 ±2
H315.4.3000-6000.H9/Z	1500	1500	111 ±2
H315.4.600-6000.H10/Z	1500	2000	111 ±2

dimensions in mm