



More information on the website
radwag.com/us/info,w1,71F

HY10.62.HRP.M2.2 High Resolution Scale



The drawings, photos and graphics used are for illustrative purposes only.

Functions

-  Dosing
-  Labelling
-  Plus/Minus Control
-  Percent Weighing
-  Totalizing
-  Parts counting
-  Peak hold
-  Formulation
-  Newton unit measurement
-  Statistics
-  Checkweighing
-  GLP Procedures
-  Animal weighing
-  Differential weighing
-  Replaceable unit
-  Statistical Quality Control
-  ALIBI Memory
-  Transactions

Datasheet

Maximum capacity [Max]	62 kg
Minimum load	100 g
Preload range	30 kg
Readability [d]	2 g

Verification unit [e]	2 g
Tare range	-62 kg
Repeatability	0,6 g
Linearity	±2 g
Stabilization time	2 s
Adjustment	internal (automatic)
OIML Class	II
Maximum quantity of verification units	31000 e
Physical parameters	
Display	10,1" graphic colour touchscreen
Weighing pan dimensions	500×400 mm
Packaging dimensions	610×710×505 mm
Net weight	37 kg
Gross weight	52 kg
Construction	
Protection class	IP 66 / 67 construction, IP 68 / 69 terminal
Construction	mild steel St3S
Weighing pan material	Stainless steel AISI304
Communication interface	2×RS232, 2×USB-A, Ethernet, 4 IN / 4 OUT (digital)
Optional interfaces	module Wi-Fi 802.11 b/g/n, module Profibus (DP SLAVE), module RS485, module PROFINET (RJ45), analog output module (4-20mA, 0-20mA, 0-10V) , 12IN / 12OUT (IN – 5-24 VDC, OUT – max 30 VDC, 0,5 ADC)
Power supply	100 – 240 V AC 50/60 Hz
Operating temperature	+10 – +40 °C
Relative humidity	15% – 80%

* Wi-Fi® is a registered trademark of Wi-Fi® Alliance.



Extra payment for verification



Accessories

RS 232 cables (scale - printer)
 Transponder card readers
 RS 232 cables (scale - ZEBRA printer)
 RS 232 cables (scale - Ethernet)
 Displays
 RS 232, RS 485 cables
 IN/OUT Cables
 Barcode scanners

Label Printers
 Stands, wall mounting kits and mounting brackets
 Keypad, external switches
 Receipt Printer
 USB cable (scale - printer)
 Additional Weighing platforms Module
 Additional modules
 RS 232 – USB Converter

Software

- E2R Weighing [WX-010-0099]
- E2R Weighing Records [WX-010-0038]
- Audit Trail Reader [WX-010-0186]
- RADWAG Remote Desktop [WX-010-0107]
- RADWAG Development Studio [WX-010-0104]

- E2R Formulations [WX-010-0043]
- RAD Key [WX-010-0005]
- Label Editor R02 [WX-010-0094]
- Scale Editor - EWAG 2.1 [WX-010-0173]

Device dimensions

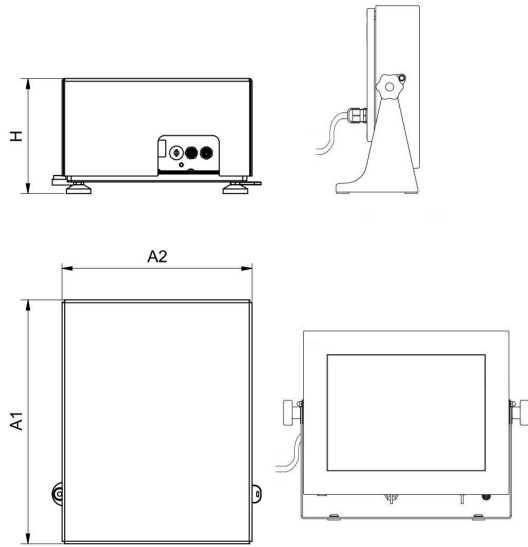

HY10.16 - 32.HRP

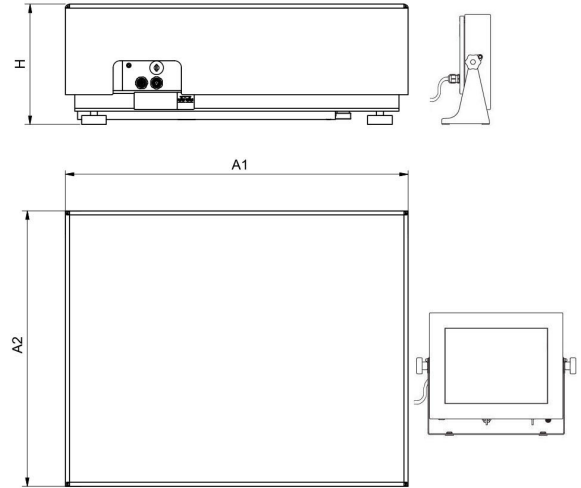

HY10.HRP

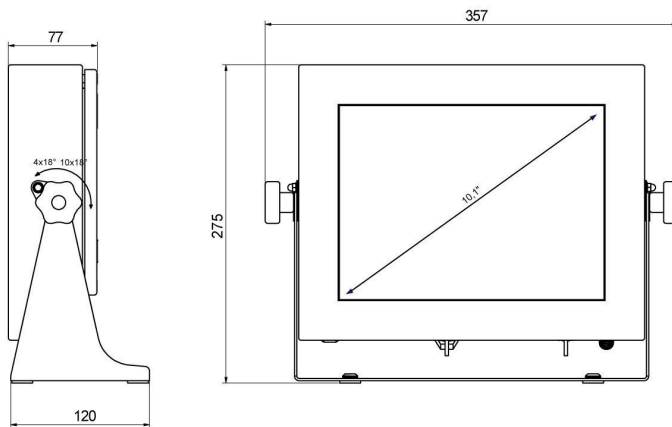

PUE HY10

Scale type	A1	A2	H
HY10.(16-32).HRP	360	280	180±5
HY10.(62-150).HRP	500	400	180±5
HY10.150.2.HRP	500	500	180±5
HY10.(150.1-300).HRP	800	600	180±5
HY10.(300.1-1100).HRP	1000	800	180±5
HY10.(2000).HRP	1250	1000	180±5

Dimensions in mm