



More information on the website
radwag.com/en/info,w1,7C6

WLY 60.C2.R.PGC Scale



The drawings, photos and graphics used are for illustrative purposes only.

Functions

-  Dosing
-  Labelling
-  Plus/Minus Control
-  Percent Weighing
-  Totalizing
-  Parts counting
-  Peak hold
-  Formulation
-  Newton unit measurement
-  Statistics
-  Checkweighing
-  IR sensors
-  Animal weighing
-  Differential weighing
-  Packaged Goods Control
-  ALIBI Memory

Datasheet

| Metrological parameters | |
|-------------------------|---------|
| Maximum capacity [Max] | 60 kg |
| Minimum load | 0.5 kg |
| Readability [d] | 10 g |
| Verification unit [e] | 10 g |
| Tare range | -120 kg |
| Repeatability | 10 g |

| Metrological parameters | |
|--------------------------|-------------------------------------------------------------------------------|
| Linearity | ±10 g |
| Stabilization time | 3 s |
| Adjustment | external |
| OIML Class | II |
| Physical parameters | |
| Leveling system | manual |
| Display | 5.7" resistive colour touchscreen |
| Weighing pan dimensions | 400×500 mm |
| Packaging dimensions | 720×620×210 mm |
| Net weight | 12.5 kg |
| Gross weight | 15 kg |
| Construction | |
| Protection class | IP 43 |
| Communication interface | |
| Communication interface | 2×RS232, 2×USB-A, Ethernet, 4 IN / 4 OUT (digital), Wi-Fi |
| Electrical parameters | |
| Power supply | Adapter: 100 – 240V AC 50/60Hz 1A; 15V DC 2.4A Balance: 10 – 28V DC 1A max |
| Environmental conditions | |
| Operating temperature | +15 – +30 °C |
| Storage temperature | -25 – +70 °C |
| Relative humidity | 10% – 85% RH no condensation |

* Wi-Fi® is a registered trademark of Wi-Fi® Alliance.



Accessories

Transponder card readers
Power Adapters
RS 232 cables (scale - printer)
Cigarette lighter receptacle power supply cables
Barcode scanners
Under-pan weighing
RS 232, RS 485 cables
Label Printers
Additional modules
Displays

IN/OUT Cables
Keypad, external switches
Stands, wall mounting kits and mounting brackets
Receipt Printer
F1 Mass Standard - knob weights without adjustment chamber, set
AP2-1 Current Loop Unit
RS 232, RS 485 cables
Additional Weighing platforms Module
RS 232 – USB Converter
RS 232 cables (scale - printer)

Software

- E2R Weighing [WX-010-0099]
- E2R Weighing Records [WX-010-0038]
- Audit Trail Reader [WX-010-0186]
- RADWAG Remote Desktop [WX-010-0107]

- E2R PGC [WX-010-0051]
- RAD Key [WX-010-0005]
- Label Editor R02 [WX-010-0094]
- R-Lab [WX-010-0080]

Device dimensions



F1 version

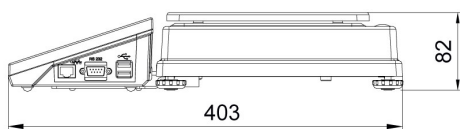

D2 version

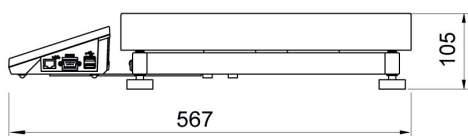
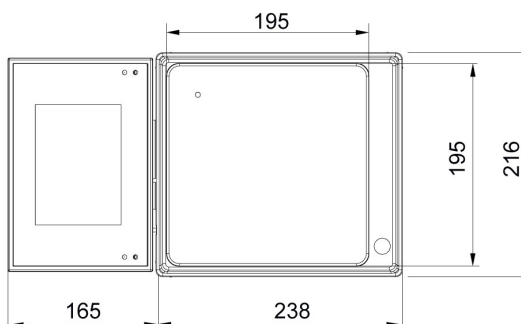

C2 version

