

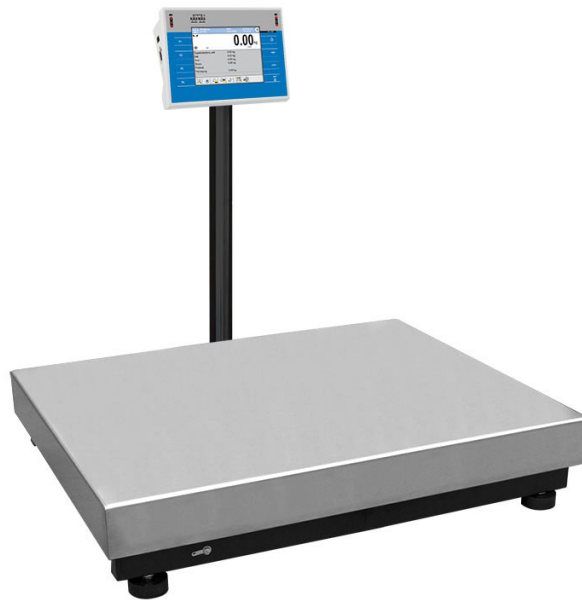

















More information on the website
radwag.com/it/info,w1,736

Bilancia multi funzione WPY 150/C2



The drawings, photos and graphics used are for illustrative purposes only.

funzioni

-  Dosing
-  Labelling
-  Plus/Minus Control
-  Percent Weighing
-  Totalizing
-  Parts counting
-  Peak hold
-  Formulation
-  Newton unit measurement
-  Statistics
-  Checkweighing
-  IR sensors
-  Animal weighing
-  Differential weighing
-  ALIBI Memory

Foglio di calcolo

Parametri metrologici	
Capacità massima [Max]	150 kg
Pesata minima	1 kg
Accuratezza	50 g
Intervallo di tara	-150 kg
Massima leggibilità per bilance non verificate	5 g
Tempo di stabilizzazione	2 s

Parametri metrologici	
Calibrazione	external
Classe OIML	III
Parametri fisici	
Display	5,7" Resistiv-Farb-Touchscreen
Dimensioni del piatto di pesata	400×500 mm
Dimensioni del pacco	720×620×210 mm
Peso netto	12,5 kg
Peso lordo	15 kg
Costruzione	
Punteggio IP	IP 43
Interfaccia di comunicazione	
Interfaccia	2×RS232, 2×USB-A, Ethernet, 4 IN / 4 OUT (digital), Wi-Fi
Parametri elettrici	
Alimentatore	100 – 240 V AC 50/60 Hz
Environmental conditions	
Temperatura di lavoro	-10 ÷ +40 °C

* Wi-Fi® is a registered trademark of Wi-Fi® Alliance.



Extra payment for verification



Accessori

Lettore di tessere transponder
 Cavo seriale RS 232 (connessione bilance - Stampanti)
 Cavo di alimentazione con spina per accendisigari
 Lettore di codici a barre
 Cavo seriale RS 232, RS 485
 stampanti per etichette
 Tavoli antivibranti
 Display
 cavi IN/OUT

Tastiera, interruttori esterni
 Supporto, set di montaggio a muro e braccetti di montaggio
 Stampanti di ricevuta
 Pesi standard F1 - cilindrici, set
 AP2-1 Power loop output
 Cavo seriale RS 232, RS 485
 Moduli aggiuntivi della piattaforma
 RS 232 – USB Converter
 Cavo seriale RS 232 (connessione bilance - Stampanti)

Software

- E2R Weighing [WX-010-0099]
- E2R PGC [WX-010-0051]
- RAD Key [WX-010-0005]
- Editore di etichette R02 [WX-010-0094]
- R-LAB [WX-010-0080]
- Software „Development Studio” RADWAG [WX-010-0104]

- E2R Formulazione [WX-010-0043]
- E2R Weighing Records [WX-010-0038]
- Audit Trail Reader [WX-010-0186]
- RADWAG Remote Desktop [WX-010-0107]
- Editore per sistemi di pesatura 2.1 [WX-010-0173]

Device dimensions

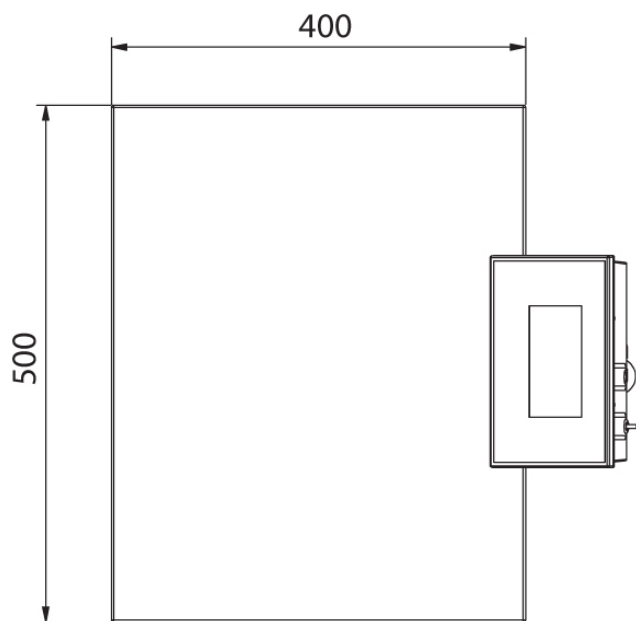
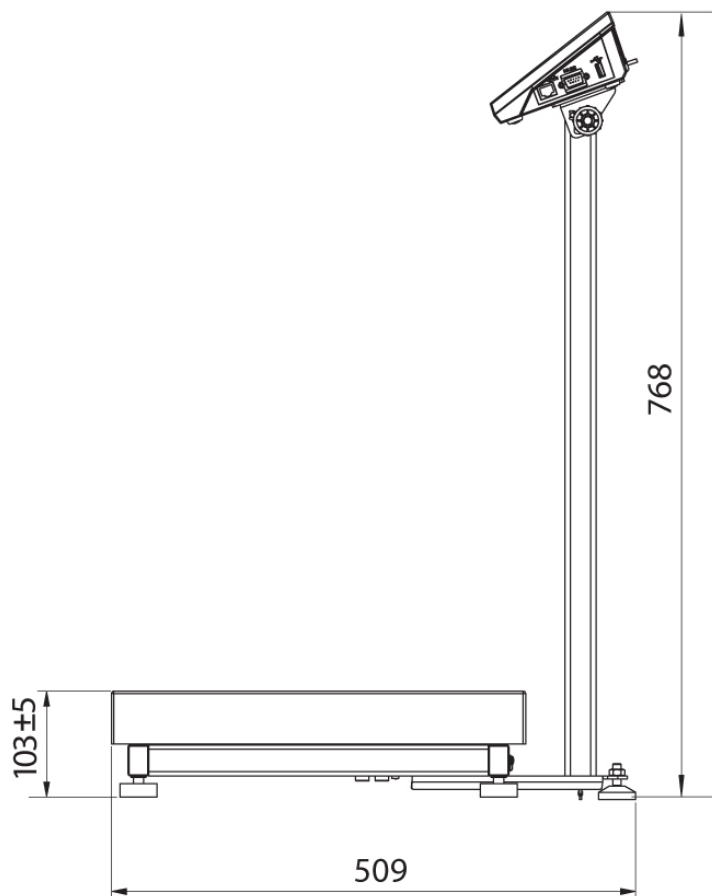

WPY C2/M