





















More information on the website  
radwag.com/it/info,w1,70L

# HY10.120.HRP.H Basamenti ad alta risoluzione



The drawings, photos and graphics used are for illustrative purposes only.

## Funzioni

-  Dosing
-  Labelling
-  Plus/Minus Control
-  Percent Weighing
-  Totalizing
-  Parts counting
-  Peak hold
-  Formulation
-  Newton unit measurement
-  Statistics
-  Checkweighing
-  GLP Procedures
-  Animal weighing
-  Differential weighing
-  Replaceable unit
-  Statistical Quality Control
-  ALIBI Memory
-  Transactions

## Specifiche

Parametri metrologici	
Portata massima [Max]	120 kg
Portata minima [Min]	50 g
Intervallo di precarico	30 kg
Divisione [d]	0,5 g

Parametri metrologici	
Campo di tara	-120 kg
Ripetibilità	0,3 g
Linearità	±2 g
Tempo di stabilizzazione	3 s
Calibrazione	internal (automatic)
Parametri fisici	
Display	10,1" graphic colour touchscreen
Dimensione piatto	500×400 mm
Dimensioni del pacco	610×710×505 mm
Peso netto	37 kg
Peso lordo	52 kg
Costruzione	
Punteggio IP	IP 66 / 67 construction, IP 68 / 69 terminal
Costruzione	Stainless steel AISI304
Materiale da pesata	Stainless steel AISI304
Interfaccia di comunicazione	
Interfaccia	2×RS232, 2×USB-A, Ethernet, 4 IN / 4 OUT (digital)
Interfacce opzionali	module Wi-Fi 802.11 b/g/n, module Profibus (DP SLAVE), module RS485, module PROFINET (RJ45), analog output module (4-20mA, 0-20mA, 0-10V) , 12IN / 12OUT (IN – 5-24 VDC, OUT – max 30 VDC, 0,5 ADC)
Parametri elettrici	
Alimentatore	100 – 240 V AC 50/60 Hz
Environmental conditions	
Ambiente di lavoro	+10 – +40 °C
Umidità relativa	15% – 80%

**La ripetibilità** è espressa come deviazione standard di 10 cariche.

**Umidità relativa** - in condizioni di non condensazione.

**Tempo di stabilizzazione** - in condizioni ambientali ottimali.

\* Wi-Fi® is a registered trademark of Wi-Fi® Alliance.



## Accessori

Cavo seriale RS 232 (connessione bilance - Stampanti)  
 Lettore di tessere transponder  
 Cavo seriale RS 232 (connessione bilance - Stampanti ZEBRA)  
 Cavo seriale RS 232 (connessione bilance - Ethernet)  
 Display  
 Cavo seriale RS 232, RS 485  
 cavi IN/OUT  
 Lettore di codici a barre

stampanti per etichette  
 Supporto, set di montaggio a muro e braccetti di montaggio  
 Tastiera, interruttori esterni  
 Stampanti di ricevuta  
 cavo USB (connessione bilance - stampanti)  
 Moduli aggiuntivi della piattaforma  
 Moduli aggiuntivi  
 RS 232 – USB Converter

## Software

- E2R Weighing [WX-010-0099]
- E2R Weighing Records [WX-010-0038]
- Audit Trail Reader [WX-010-0186]
- RADWAG Remote Desktop [WX-010-0107]
- Editore per sistemi di pesatura 2.1 [WX-010-0173]
- E2R Formulazione [WX-010-0043]
- RAD Key [WX-010-0005]
- Editore di etichette R02 [WX-010-0094]
- R-LAB [WX-010-0080]
- Software „Development Studio” RADWAG [WX-010-0104]

## Device dimensions

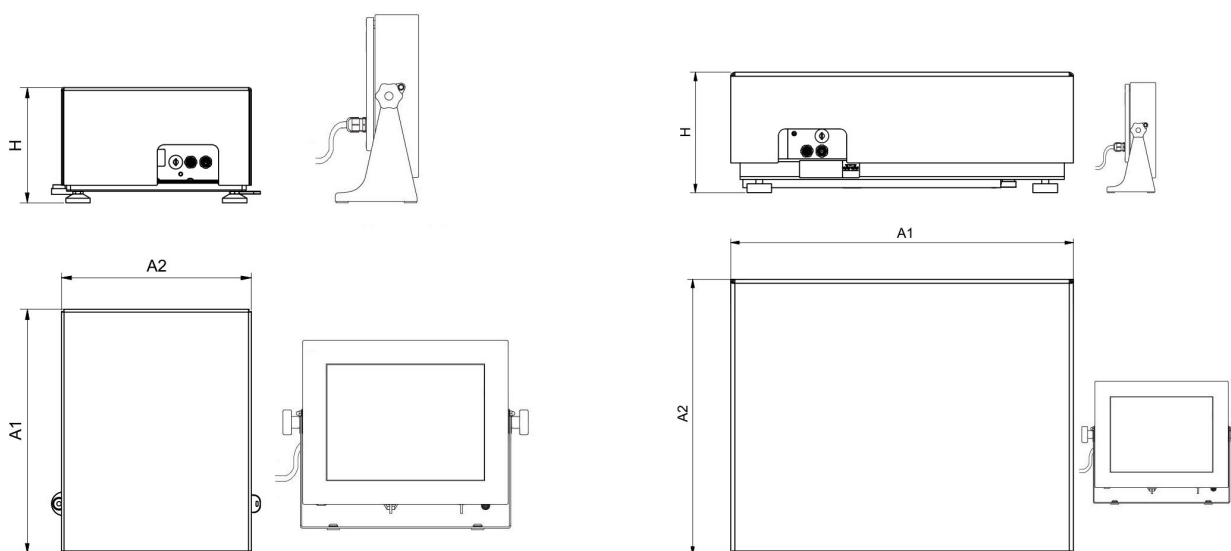

HY10.16 - 32.HRP.H

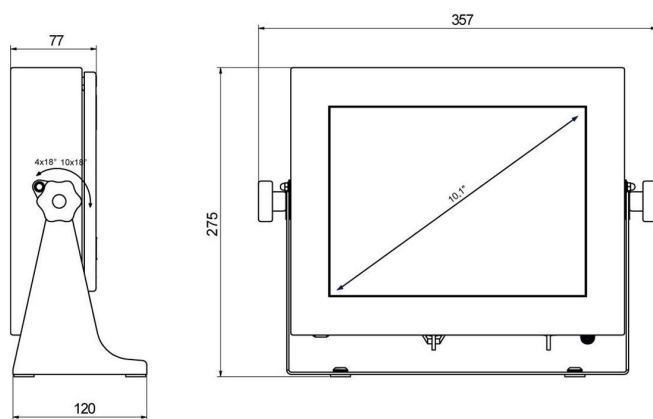

PUE HY10

Scale type	A1	A2	H
HY10.(16-32).HRP.H	360	280	180±5
HY10.(62-150).HRP.H	500	400	180±5
HY10.150.2.HRP.H	500	500	180±5
HY10.(150.1-300).HRP.H	800	600	180±5
HY10.(300.1-1100).HRP.H	1000	800	180±5
HY10.(2000).HRP.H	1250	1000	180±5

Dimensions in mm