

















More information on the website  
[radwag.com/fr/info,w1,6Z1](http://radwag.com/fr/info,w1,6Z1)

# Balance de précision WLY 1/D2



The drawings, photos and graphics used are for illustrative purposes only.

## Fonctions

-  Dosing
-  Labelling
-  Plus/Minus Control
-  Percent Weighing
-  Totalizing
-  Parts counting
-  Peak hold
-  Formulation
-  Newton unit measurement
-  Statistics
-  Checkweighing
-  IR sensors
-  Animal weighing
-  Differential weighing
-  ALIBI Memory

## Paramètres Techniques

Paramètres métrologiques	
Capacité maximale [Max]	1 kg
Capacité minimale [Min]	-
Précision de lecture	0,01 g
Échelon de légalisation [e]	-
Étendue de tare	-1 kg
Répétabilité	0,03 g

Paramètres métrologiques	
Linéarité	±0,03 g
Temps de stabilisation	3 s
Ajustage	externe
Classe de précision OIML	-
Paramètres physiques	
Système de nivellement	manuel
Afficheur	5,7" Écran tactile couleur résistif
Dimension du plateau	195×195 mm
Dimensions de colis	530×310×150 mm
Masse nette	2,7 kg
Masse brute	3,6 kg
Construction	
Degré de protection	IP 43
Interface de Communication	
Interface de Communication	2×RS232, 2×USB-A, Ethernet, 4 IN / 4 OUT (numériques), Wi-Fi
Paramètres électriques	
Alimentation	Adapter: 100 – 240V AC 50/60Hz 1A; 15V DC 2,4A Balance: 10 – 28V DC 1A max
Conditions environnementales	
Température du travail	+15 – +30 °C
Température de stockage	-25 – +70 °C
Humidité relative d'air	10% – 85% RH sans condensation

**Répétabilité** exprimée comme un écart standardisé de 10 placements de chargé.

**Temps de stabilisation** dépend de conditions externes et de la dynamique du placement d'un poids sur le plateau; déterminé pour le profil FAST.

\* Wi-Fi® is a registered trademark of Wi-Fi® Alliance.



## Accessoires

Tables antivibratoires  
Alimentateurs  
Câbles RS 232 (balance – imprimante)  
Câbles d'alimentation de cigare-allume  
Lecteurs de code-barres  
Câbles RS 232, RS 485  
Imprimantes d'étiquettes  
Modules complémentaires  
Afficheurs

Câbles d'Entrées/ de Sorties  
Claviers, manipulateurs  
Supports, Statifs, bras-supports  
Imprimante de tickets de caisse  
Sorties de boucle de courant AP2-1  
Câbles RS 232, RS 485  
Modules de plateforme supplémentaires  
Convertisseur RS 232 – USB  
Câbles RS 232 (balance – imprimante)

## Software

• E2R Pesages [WX-010-0099]  
• E2R Registre [WX-010-0038]

• E2R Recettes [WX-010-0043]  
• RAD Key [WX-010-0005]

- Audit Trail Reader [WX-010-0186]
- RADWAG Remote Desktop [WX-010-0107]
- Éditeur de Balances 2.1 [WX-010-0173]

- Éditeur D'étiquettes R02 [WX-010-0094]
- R-LAB [WX-010-0080]
- RADWAG Studio du Développement [WX-010-0104]

## Dimensions d'appareil

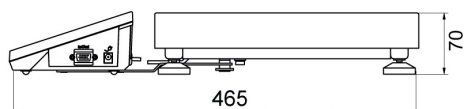

F1 version

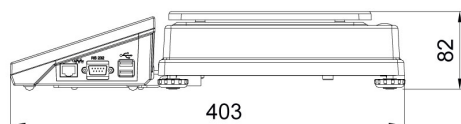
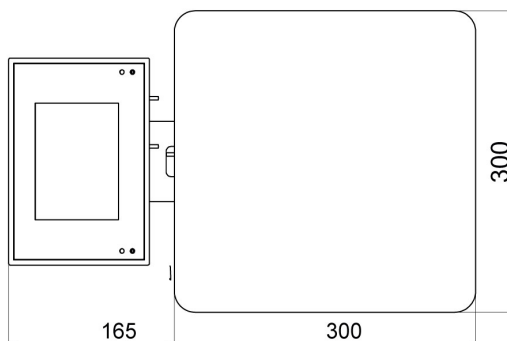

D2 version

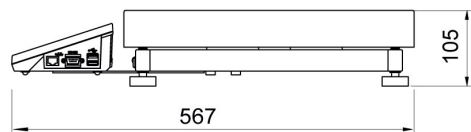
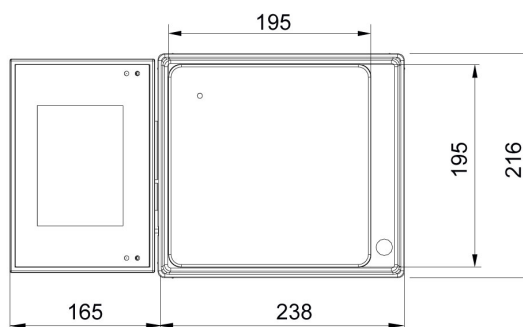

C2 version

