























More information on the website
radwag.com/it/info,w1,68V

AS 120.X2 PLUS Bilancia analitica



The drawings, photos and graphics used are for illustrative purposes only.

funzioni

-  Autotest
-  Dosing
-  Percent Weighing
-  Parts counting
-  Peak hold
-  Formulation
-  Newton unit measurement
-  Statistics
-  Checkweighing
-  IR sensors
-  Under-pan weighing
-  GLP Procedures
-  Animal weighing
-  Density determination
-  Ambient conditions monitoring
-  Replaceable unit
-  Statistical Quality Control
-  ALIBI Memory
-  Mass for titrator
-  Wi-Fi

Foglio di calcolo

Parametri metrologici	
Capacità massima [Max]	120 g
Pesata minima	1 mg
Accuratezza	0,01 mg
Intervallo di verifica della bilancia [e]	1 mg

Parametri metrologici	
Intervallo di tara	-120 g
Ripetibilità standard [5% massimo]	0,01 mg
Ripetibilità standard [Max]	0,025 mg
Peso standard minimo (USP)	20 mg
Peso standard minimo (U = 1%, k = 2)	2 mg
Ripetibilità consentita [5% massimo]	0,02 mg
Ripetibilità consentita [Max]	0,04 mg
Linearità	±0,07 mg
Tempo di stabilizzazione	2 s
Calibrazione	internal (automatic)
Classe OIML	I
Parametri fisici	
Sistema di livellamento	półautomatyczny - LevelSENSING
Display	5" graphic color touchscreen
Porta della camera di pesatura	manual
Componenti del kit	Balance, weighing pan, weighing pan shield, centring ring, bottom cover, power supply, fabric dust cover.
Dimensioni della camera di pesata	190×190×222 mm
Dimensioni del piatto di pesata	ø90 open-work pan + ø85 (option) mm
Dimensioni del pacco	545×455×575 mm
Peso netto	7,3 kg
Peso lordo	9,3 kg
Costruzione	
Punteggio IP	IP 43
Components and software	
Capacità del database	7
Caratteristiche operative	
Operazione senza comandi diretti	2 IR Sensors
Interfaccia di comunicazione	
Interfaccia	RS232 ¹ , 2×USB-A (interchangeable), USB-B, Wi-Fi, Ethernet
Parametri elettrici	
Alimentatore	Adapter: 100 – 240V AC 50/60Hz 0,6A; 12V DC 1,2A Balance: 12 – 15V DC 0,8A max
Massimo assorbimento elettrico	4 W
Environmental conditions	
Temperatura di lavoro	+10 ÷ +40 °C
Modulo misura parametri ambientali (opzionale)	THBR 2.0 System, THBR BOX, THB P, THB W, THB S
Umidità atmosferica	40% ÷ 80%

* Wi-Fi® is a registered trademark of Wi-Fi® Alliance.



Extra payment for verification



Accessori

Tavoli antivibranti

Alimentatore

Cavo di alimentazione con spina per accendisigari

KIT determinazione della densità

cavo USB (connessione bilance - stampanti)

Tavolo di pesata professionale

Lettoce di codici a barre

Stazione di lavoro per calibrazione pipette

Cavo seriale RS 232, RS 485

THBR 2.0 - modulo misura parametri ambientali

Display

Capottina protettiva per bilance

Recipienti per pesare

Ionizzatore anti statico

Stampanti di ricevuca

Cavo seriale RS 232, RS 485

Moduli aggiuntivi

Under-pan weighing

Cavo seriale RS 232 (connessione bilance - Stampanti)

RS 232 – RS 485 Converter

Software

• RAD Key [WX-010-0005]

• R-LAB [WX-010-0080]

• Software „Development Studio“ RADWAG [WX-010-0104]

• „Alibi Reader“ PC Software [WX-010-0114]

• Editore per sistemi di pesatura 2.1 [WX-010-0173]

Device dimensions

AS X2 PLUS, d = 0.01 mg

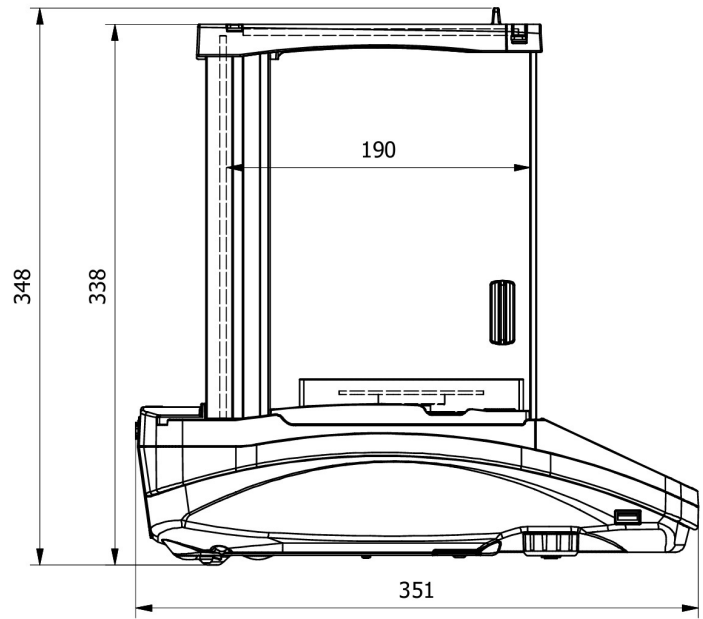

AS X2 PLUS, d = 0.1 mg

