





















More information on the website  
[radwag.com/en/info,w1,644](http://radwag.com/en/info,w1,644)

# HY10.300.1.HRP.H High Resolution Scale



The drawings, photos and graphics used are for illustrative purposes only.

## Functions

-  Dosing
-  Labelling
-  Plus/Minus Control
-  Percent Weighing
-  Totalizing
-  Parts counting
-  Peak hold
-  Formulation
-  Newton unit measurement
-  Statistics
-  Checkweighing
-  GLP Procedures
-  Animal weighing
-  Differential weighing
-  Replaceable unit
-  Statistical Quality Control
-  ALIBI Memory
-  Transactions

## Datasheet

Metrological parameters	
Maximum capacity [Max]	300 kg
Minimum load	50 g
Preload range	60 kg
Readability [d]	1 g

Metrological parameters	
Tare range	-300 kg
Repeatability	3 g
Linearity	±6 g
Stabilization time	3 s
Adjustment	internal (automatic)
Physical parameters	
Display	10" graphic colour touchscreen
Weighing pan dimensions	1000×800 mm
Packaging dimensions	1000×1200×666 mm
Net weight	126 kg
Gross weight	160 kg
Construction	
Protection class	IP 66/67 construction, IP 68/69 indicator
Construction	Stainless steel AISI304
Weighing pan material	Stainless steel AISI304
Communication interface	
Communication interface	2×RS232, 2×USB-A, Ethernet, 4 IN / 4 OUT (digital)
Optional interfaces	module Wi-Fi 802.11 b/g/n, module Profibus (DP SLAVE), module RS485, module PROFINET (RJ45), analog output module (4-20mA, 0-20mA, 0-10V) , 12IN / 12OUT (IN – 5-24 VDC, OUT – max 30 VDC, 0.5 ADC)
Electrical parameters	
Power supply	100 – 240 V AC 50/60 Hz
Environmental conditions	
Operating temperature	+10 ÷ +40 °C
Relative humidity	40% ÷ 80%

**Repeatability** is expressed as the standard deviation of ten load placements.

**Relative humidity** under non-condensing conditions.

**Stabilization time** under optimal environmental conditions.

\* Wi-Fi® is a registered trademark of Wi-Fi® Alliance.



## Accessories

RS 232 cables (scale - printer)  
 Transponder card readers  
 RS 232 cables (scale - ZEBRA printer)  
 RS 232 cables (scale - Ethernet)

Label Printers  
 Stands, wall mounting kits and mounting brackets  
 Keypad, external switches  
 Receipt Printer

Displays  
 RS 232, RS 485 cables  
 IN/OUT Cables  
 Barcode scanners

USB cable (scale - printer)  
 Additional Weighing platforms Module  
 Additional modules  
 RS 232 – USB Converter

## Software

- E2R Weighing [WX-010-0099]
- E2R Weighing Records [WX-010-0038]
- Audit Trail Reader [WX-010-0186]
- RADWAG Remote Desktop [WX-010-0107]
- Scale Editor 2.1 [WX-010-0173]
- E2R Formulations [WX-010-0043]
- RAD Key [WX-010-0005]
- Label Editor R02 [WX-010-0094]
- R-Lab [WX-010-0080]
- RADWAG Development Studio [WX-010-0104]

## Device dimensions

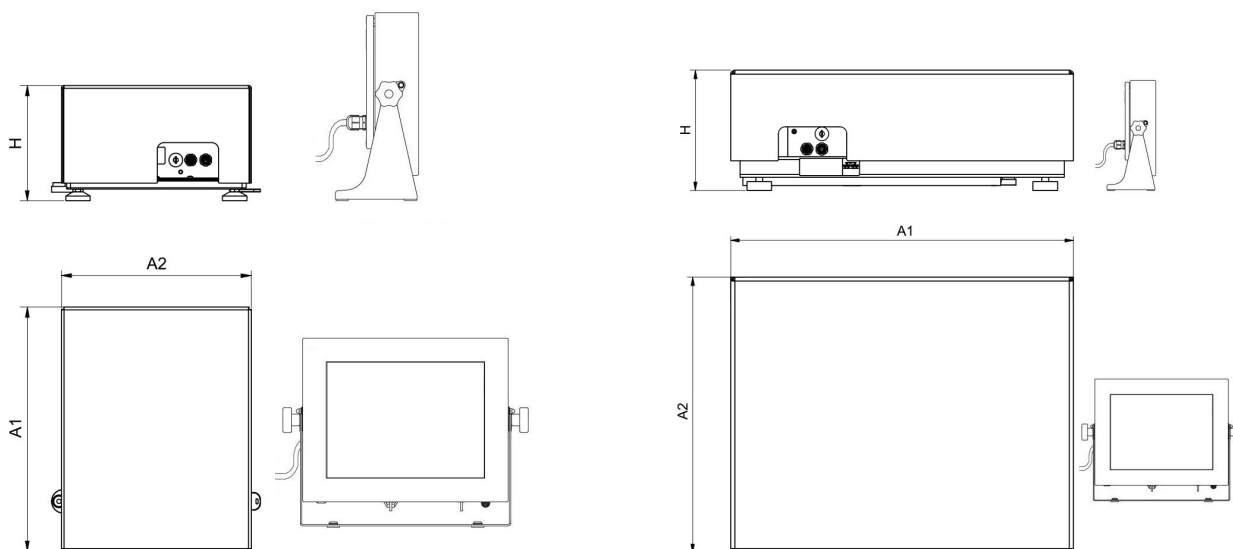

HY10.16 - 32.HRP.H

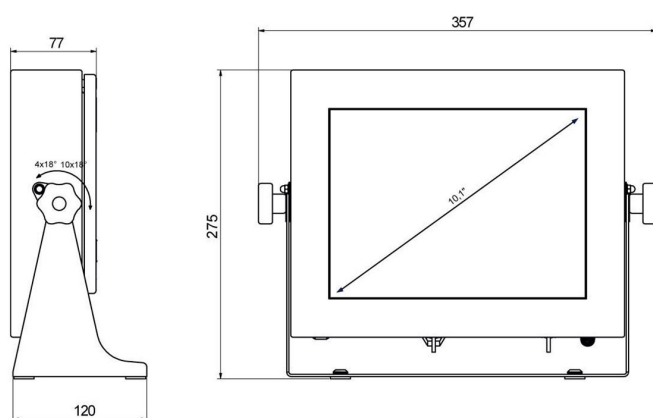

PUE HY10

Scale type	A1	A2	H
HY10.(16-32).HRP.H	360	280	180±5
HY10.(62-150).HRP.H	500	400	180±5
HY10.150.2.HRP.H	500	500	180±5
HY10.(150.1-300).HRP.H	800	600	180±5
HY10.(300.1-1100).HRP.H	1000	800	180±5
HY10.(2000).HRP.H	1250	1000	180±5

Dimensions in mm