



More information on the website  
radwag.com/es/info,w1,5NX

# Báscula multifuncional C32.1,5.F1.R



The drawings, photos and graphics used are for illustrative purposes only.

## Funciones



Etiquetado



Indicador más/menos



Desviaciones porcentuales



Suma de pesajes



Contar piezas



Medición en Newtons



Estadísticas



Sensores infrarrojos



Procedimientos GLP



Unidades intercambiables



Memoria Alibi

## Datos técnicos

Parámetros metrológicos	
Maxima capacidad [Max]	1,5 kg
Minima capacidad	10 g
Legibilidad [d]	0,5 g
Rango de tara	-1,5 kg
Legibilidad máxima para las balanzas no verificadas	0,2 g
Clase OIML	III

Parámetros físicos	
Sistema de nivelación	manual
Pantalla	5" gráfico color
Dimensión de platillo	300×300 mm
Dimensiones de embalaje	570×390×170 mm
Masa neta	5,3 kg
Masa bruta	6,1 kg
Construcción	
Grado de protección	IP 65 construcción, IP 43 medidor
Construcción	de acero con recubrimiento en polvo St3S
Material del platillo	Acero inoxidable AISI304
Interface de comunicación	
Conectividad	2×RS232, USB-A, USB-B, Ethernet, 4 IN / 4 OUT (digitales), Wi-Fi
Parámetros eléctricos	
Alimentación	100 – 240 V AC 50/60 Hz
Consumo máximo de potencia	10 W
Corriente de alimentación adicional	batería interna
Horas de trabajo con baterías	5 horas
Condiciones ambientales	
Temperatura de trabajo	-10 – +40 °C

\*Equipo opcional con costo adicional

\* Wi-Fi® is a registered trademark of Wi-Fi® Alliance.



Extra payment for verification



## Accesorios

### Pantallas

Adaptadores de corriente  
Cables RS 232 (Bascula a Impresora)  
Cables de corriente desde mechero de automóvil  
Escáner de códigos de barra  
Cables RS 232, RS 485  
Impresoras de etiquetas  
Pantallas

### Pantallas

Teclado, manipuladores  
Soportes, brazos  
Módulos adicionales  
Impresoras de recibos  
Cables RS 232, RS 485  
Cables RS 232 (Bascula a Impresora)

## Programas

- E2R Pesajes [WX-010-0099]
- RAD Key [WX-010-0005]
- Alibi Reader PC Software [WX-010-0114]
- Editor de Balanzas 2.1 [WX-010-0173]

- E2R Registro [WX-010-0038]
- Editor de Etiquetas R02 [WX-010-0094]
- R-LAB [WX-010-0080]
- RADWAG Development Studio [WX-010-0104]

# Dimensiones de aparato

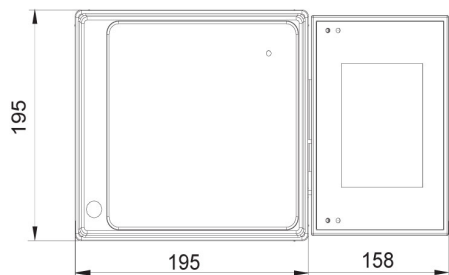
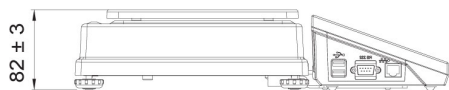

C32.D2

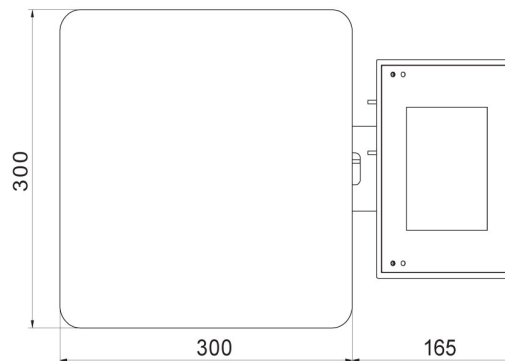
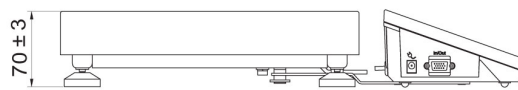

C32.F1.R

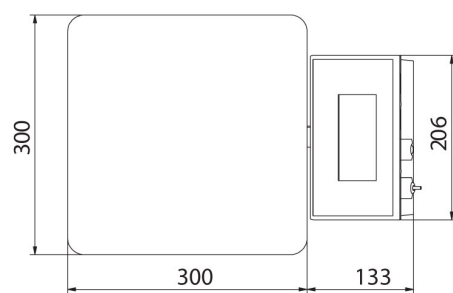
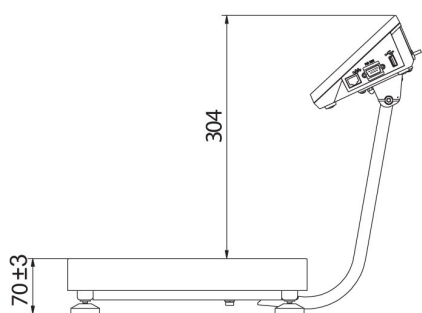

C32.F1.M

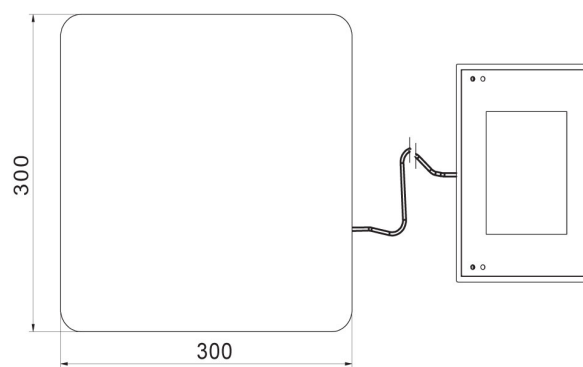
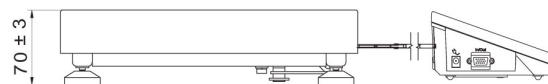

C32.F1.K