



More information on the website  
radwag.com/fr/info,w1,5AP

# Balance à haute résolution HY10.150.1.HRP.H.M2.1



The drawings, photos and graphics used are for illustrative purposes only.

## Fonctions

-  Dosing
-  Labelling
-  Plus/Minus Control
-  Percent Weighing
-  Totalizing
-  Parts counting
-  Peak hold
-  Formulation
-  Newton unit measurement
-  Statistics
-  Checkweighing
-  GLP Procedures
-  Animal weighing
-  Differential weighing
-  Replaceable unit
-  Statistical Quality Control
-  ALIBI Memory
-  Transactions

## Paramètres Techniques

Paramètres métrologiques	
Capacité maximale [Max]	150 kg
Capacité minimale [Min]	50 g
Capacité préliminaire	30 kg
Précision de lecture	1 g

Paramètres métrologiques	
Échelon de légalisation [e]	10 g
Étendue de tare	-150 kg
Répétabilité	1,5 g
Linéarité	±3 g
Temps de stabilisation	3 s
Ajustage	interne (automatique)
Classe de précision OIML	II
Nombre maximal d'échelons de légalisation	15000 e
Paramètres physiques	
Afficheur	10" graphique couleurs écran tactile
Dimension du plateau	800x600 mm
Dimensions de colis	800x1000x537 mm
Masse nette	71,5 kg
Masse brute	119 kg
Construction	
Degré de protection	IP 66/67 construction, IP 68/69 terminal
Construction	Acier inoxydable AISI304
Matériel du plateau	Acier inoxydable AISI304
Interface de Communication	
Interface de Communication	2xRS232, 2xUSB-A, Ethernet, 4 IN / 4 OUT (numériques)
Interfaces optionnelles	module Wi-Fi 802.11 b/g/n, module Profibus (DP SLAVE), module RS485, module PROFINET (RJ45), module de sorties analogiques (4-20mA, 0-20mA, 0-10V) , 12IN / 12OUT (IN – 5-24 VDC, OUT – max 30 VDC, 0,5 ADC)
Paramètres électriques	
Alimentation	100 – 240 V AC 50/60 Hz
Conditions environnementales	
Température du travail	+10 ÷ +40 °C
Humidité relative d'air	40% ÷ 80%

**La répétabilité** est exprimée en écart-type de dix positions de charge.

**Humidité relative de l'air** dans des conditions sans condensation.

**Temps de stabilisation** dans des conditions ambiantes optimales.

\* Wi-Fi® is a registered trademark of Wi-Fi® Alliance.



Extra payment for verification



## Accessoires

Câbles RS 232 (balance – imprimante)  
 Lecteurs de cartes à transpondeur  
 Câbles RS 232 (balance – imprimante ZEBRA)  
 Câbles de réseau (balance – Ethernet)  
 Afficheurs  
 Câbles RS 232, RS 485  
 Câbles d'Entrées/ de Sorties  
 Lecteurs de code-barres

Imprimantes d'étiquettes  
 Supports, Statifs, bras-supports  
 Claviers, manipulateurs  
 Imprimante de tickets de caisse  
 Câble USB (balance – imprimante)  
 Modules de plateforme supplémentaires  
 Modules complémentaires  
 Convertisseur RS 232 – USB

## Software

- E2R Pesages [WX-010-0099]
- E2R Registre [WX-010-0038]
- Audit Trail Reader [WX-010-0186]
- RADWAG Remote Desktop [WX-010-0107]
- Éditeur de Balances 2.1 [WX-010-0173]
- E2R Recettes [WX-010-0043]
- RAD Key [WX-010-0005]
- Éditeur D'étiquettes R02 [WX-010-0094]
- R-LAB [WX-010-0080]
- RADWAG Studio du Développement [WX-010-0104]

## Dimensions d'appareil

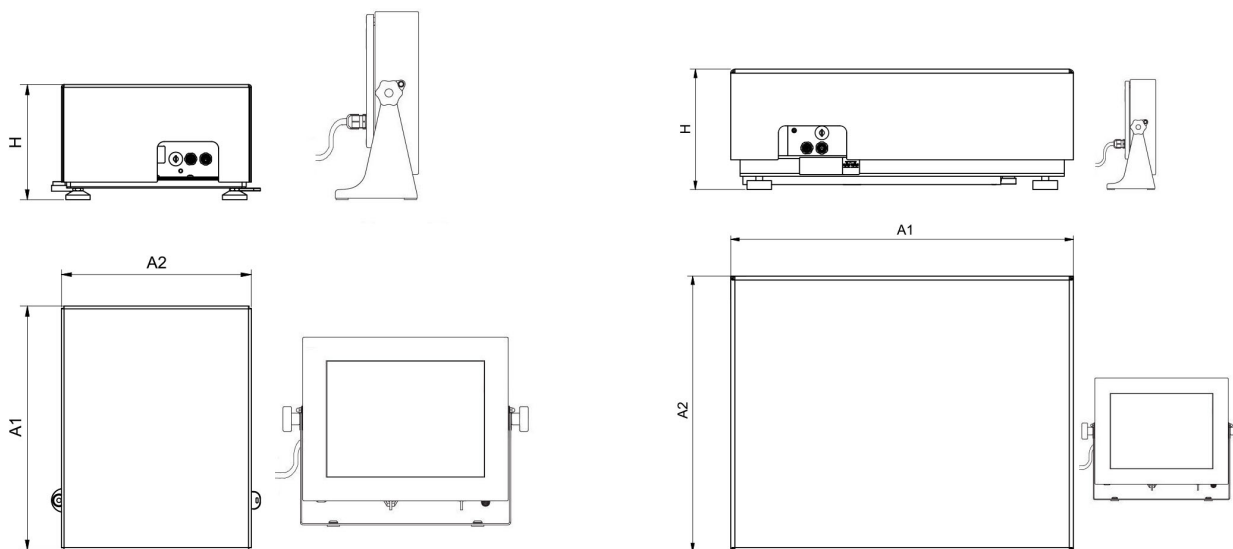

HY10.16 - 32.HRP.H

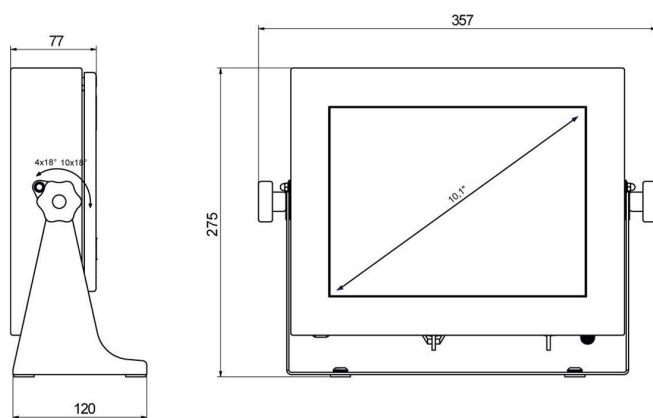

PUE HY10

Scale type	A1	A2	H
HY10.(16-32).HRP.H	360	280	180±5
HY10.(62-150).HRP.H	500	400	180±5
HY10.150.2.HRP.H	500	500	180±5
HY10.(150.1-300).HRP.H	800	600	180±5
HY10.(300.1-1100).HRP.H	1000	800	180±5
HY10.(2000).HRP.H	1250	1000	180±5

Dimensions in mm