



More information on the website  
radwag.com/tr/info,w1,343

## C32.3.F1.K Çok Fonksiyonlu Terazı



The drawings, photos and graphics used are for illustrative purposes only.

### Fonksiyonlar



Labelling



Plus/Minus Control



Percent Weighing



Totalizing



Parts counting



Newton unit  
measurement



Statistics



IR sensors



GLP Procedures



Replaceable unit



ALIBI Memory

### Teknik Veriler

#### Metrolojik parametreler

Maksimum yük [Max]	3 kg
Minimum yük [Min]	20 g
Okuma için doğruluğu [d]	1 g
Dara aralığı	-3 kg
Ticari amaçla kullanılmayan terazi için maksimum hassasiyet	0,2 g
OIML sınıfı	III

Fiziksel parametreler	
Display	5" grafik renkli
Kablo uzunluğu	1 m
Tartım kefesi boyutları	300×300 mm
Ambalaj boyutları	570×390×170 mm
Net ağırlık	5,3 kg
Brüt ağırlık	6,1 kg
Konstrüksiyon	
IP Sınıfı	IP 65 konstrüksiyon, IP 43 terminal
Konstrüksiyon	toz kaplı çelik St3S
Tartım kefesi	Paslanmaz çelik AISI304
Haberleşme arayüzler	
Haberleşme arayüzü	2×RS232, USB-A, USB-B, Ethernet, 4 IN / 4 OUT (dijital), Wi-Fi
Elektrik parametreleri	
Güç kaynağı	100 – 240 V AC 50/60 Hz
Maksimum güç tüketimi	10 W
Opsiyonel güç kaynağı	dahili batarya
Batarya ile çalışma süresi	5 saate kadar sürekli çalışma
Çevresel koşullar	
Çalıştırma sıcaklığı	-10 – +40 °C

\* Ek ücret karşılığında isteğe bağlı donanım

\* Wi-Fi® is a registered trademark of Wi-Fi® Alliance.



Extra payment for verification



## Aksesuarlar

Display  
Güç adaptörü  
RS 232 cables (scale - printer)  
Çakmak prizine uygun besleme kabloları  
Barkod okuyucu  
RS 232, RS 485 cables  
Etiket Yazıcısı  
Display

Display  
Klavye  
Tartım terminalleri için tutucular  
Ek modüller  
Fiş yazıcı  
RS 232, RS 485 Kabloları  
Kablolar RS 232 (Teraziler - Yazıcı)

## Yazılım

- E2R Tartım [WX-010-0099]
- RAD Key [WX-010-0005]
- Alibi Okuyucu PC Yazılımı [WX-010-0114]
- Terazi Editörü - EWAG 2.1 [WX-010-0173]

- E2R Tartı Kayıtları [WX-010-0038]
- Etiket Editörü R02 [WX-010-0094]
- R-Lab [WX-010-0080]
- RADWAG Development Studio [WX-010-0104]

# Cihaz boyutları

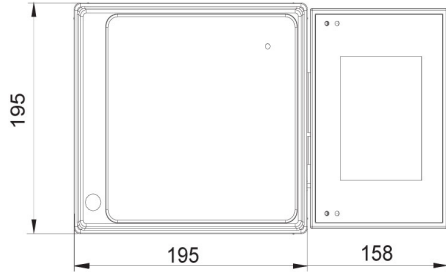
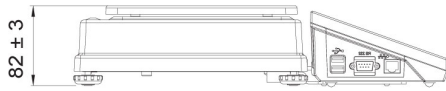

C32.D2

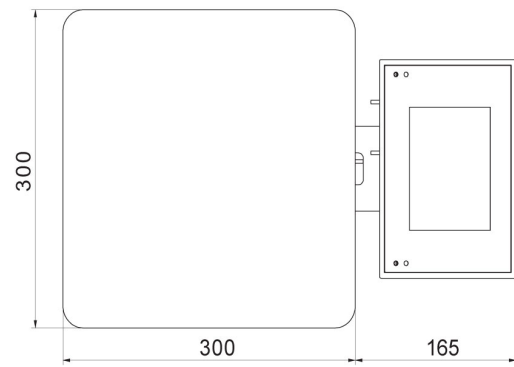
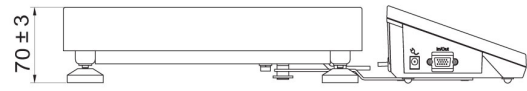

C32.F1.R

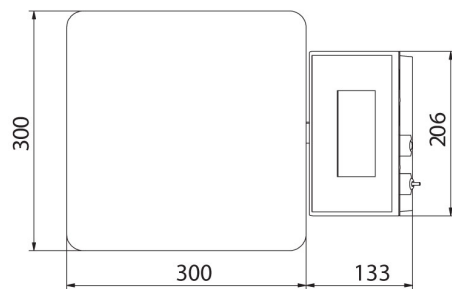
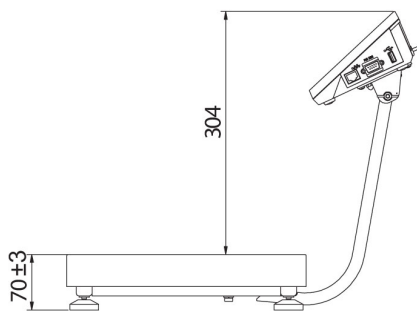

C32.F1.M

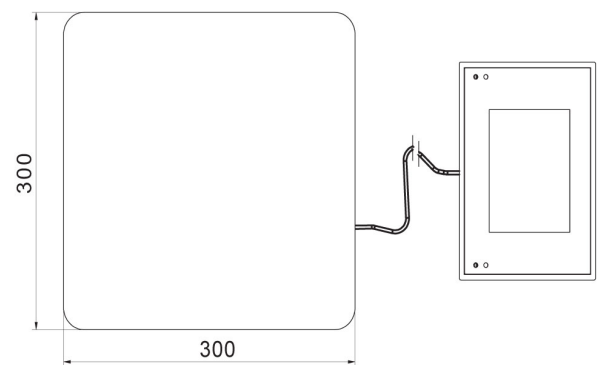
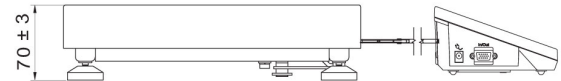

C32.F1.K