



More information on the website  
radwag.com/it/info,w1,343

# Bilancia multifunzione C32.3.F1.K



The drawings, photos and graphics used are for illustrative purposes only.

## funzioni



Labelling



Plus/Minus Control



Percent Weighing



Totalizing



Parts counting



Newton unit measurement



Statistics



IR sensors



Under-pan weighing



GLP Procedures



Replaceable unit



ALIBI Memory

## Foglio di calcolo

### Parametri metrologici

Capacità massima [Max]	3 kg
Pesata minima	20 g
Accuratezza	1 g
Intervallo di tara	-3 kg
Massima leggibilità per bilance non verificate	0,2 g
Classe OIML	III

Parametri fisici	
Display	5" graphic colour
Dimensioni del piatto di pesata	300×300 mm
Dimensioni del pacco	570×390×170 mm
Peso netto	5,3 kg
Peso lordo	6,1 kg
Lunghezza del cavo	1 m
Costruzione	
Punteggio IP	IP 65 construction, IP 43 indicator
Costruzione	mild steel St3S
Materiale da pesata	Stainless steel AISI304
Interfaccia di comunicazione	
Interfaccia	2×RS232, USB-A, USB-B, Ethernet, 4 IN / 4 OUT (digital), Wi-Fi
Parametri elettrici	
Alimentatore	100 – 240 V AC 50/60 Hz
Massimo assorbimento elettrico	10 W
Alimentatore opzionale	internal rechargeable battery
Tempo operativo delle batterie	operation time up to 5 h
Environmental conditions	
Temperatura di lavoro	-10 ÷ +40 °C

\* Wi-Fi® is a registered trademark of Wi-Fi® Alliance.



Extra payment for verification



## Accessori

Display  
 Alimentatore  
 Cavo seriale RS 232 (connessione bilance - Stampanti)  
 Cavo di alimentazione con spina per accendisigari  
 Lettore di codici a barre  
 Cavo seriale RS 232, RS 485  
 stampanti per etichette  
 Display

Display  
 Tastiera, interruttori esterni  
 Supporto, set di montaggio a muro e braccetti di montaggio  
 Moduli aggiuntivi  
 Stampanti di ricevuata  
 Cavo seriale RS 232, RS 485  
 Cavo seriale RS 232 (connessione bilance - Stampanti)

## Software

- E2R Weighing [WX-010-0099]
- RAD Key [WX-010-0005]
- „Alibi Reader” PC Software [WX-010-0114]
- Editore per sistemi di pesatura 2.1 [WX-010-0173]

- E2R Weighing Records [WX-010-0038]
- Editore di etichette R02 [WX-010-0094]
- R-LAB [WX-010-0080]
- Software „Development Studio” RADWAG [WX-010-0104]

## Device dimensions

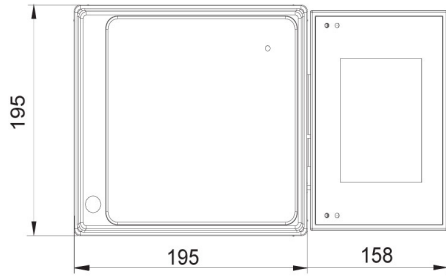
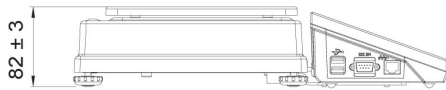

C32.D2

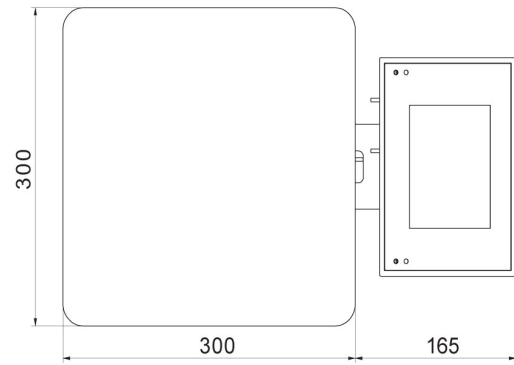
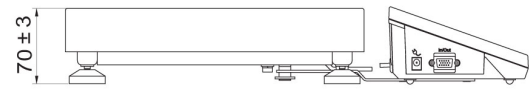

C32.F1.R

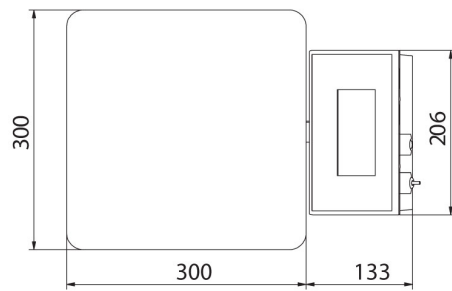

C32.F1.M

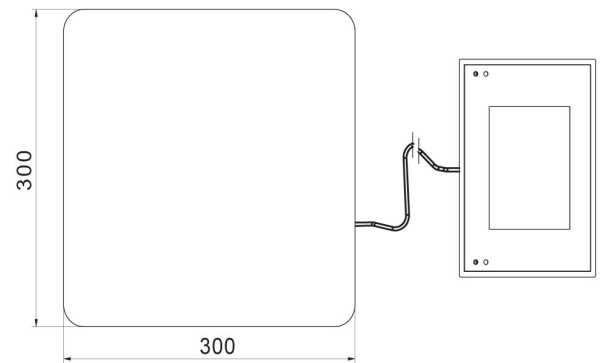
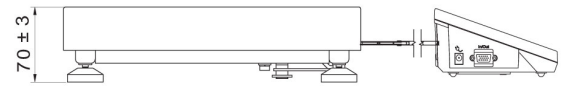

C32.F1.K