



More information on the website  
[radwag.com/es/info,w1,27M](http://radwag.com/es/info,w1,27M)

# Báscula impermeable H315.60/150.HR3.M





The drawings, photos and graphics used are for illustrative purposes only.

## Funciones

 Indicador más/menos

 Desviaciones porcentuales

 Suma de pesajes

 Contar piezas

 Batería interna

 Cierre del pesaje máximo

 Medición en Newtons

 Pesaje de animales

## Datos técnicos

### Parámetros metrológicos

Maxima capacidad [Max]	60 / 150 kg
Minima capacidad	400 g
Legibilidad [d]	20 / 50 g
División de legalización [e]	20 g
Rango de tara	-150 kg
Clase OIML	III

### Parámetros físicos

Pantalla	LCD (con retroiluminación)
Dimensión de platillo	410x410 mm

Parámetros físicos	
Dimensiones de embalaje	510×510×270 mm
Masa neta	15,5 kg
Masa bruta	17,3 kg
Construcción	
Grado de protección	IP 68 construcción, IP 68 extensómetro, IP 68 (1h max)/69 medidor
Construcción	Acero inoxidable AISI316
Interface de comunicación	
Conectividad	RS232, USB
Interfaces opcionales	RS232 o RS485 o 4IN/4OUT o Ethernet o entradas analógica 4-20 mA
Parámetros electricos	
Alimentación	100 – 240 V AC 50/60 Hz
Corriente de alimentación adicional	batería interna
Horas de trabajo con baterías	max 7h
Condiciones ambientales	
Temperatura de trabajo	-10 – +40 °C
Temperatura de almacenamiento	-25 – +70 °C
Humedad relativa de aire	10% – 85% RH sin condensación



Extra payment for verification



## Accesorios

Cables RS 232 (Bascula a Impresora)  
Mesas antivibratil  
Pantallas  
Cables de corriente (Bascula a Ethernet)  
Cables RS 232, RS 485  
Convertidor RS 232 a Ethernet  
Adaptadores USB

Impresoras de recibos  
Cable USB (Bascula a Impresora)  
Soportes, brazos  
Convertidor RS 232 a USB  
Soportes con transportadores con rollos  
Cables RS 232, RS 485

## Programas

• RAD Key [WX-010-0005]  
• R-LAB [WX-010-0080]

• R Panel [WX-010-0187]  
• Editor de Balanzas 2.1 [WX-010-0173]

## Dimensiones de aparato

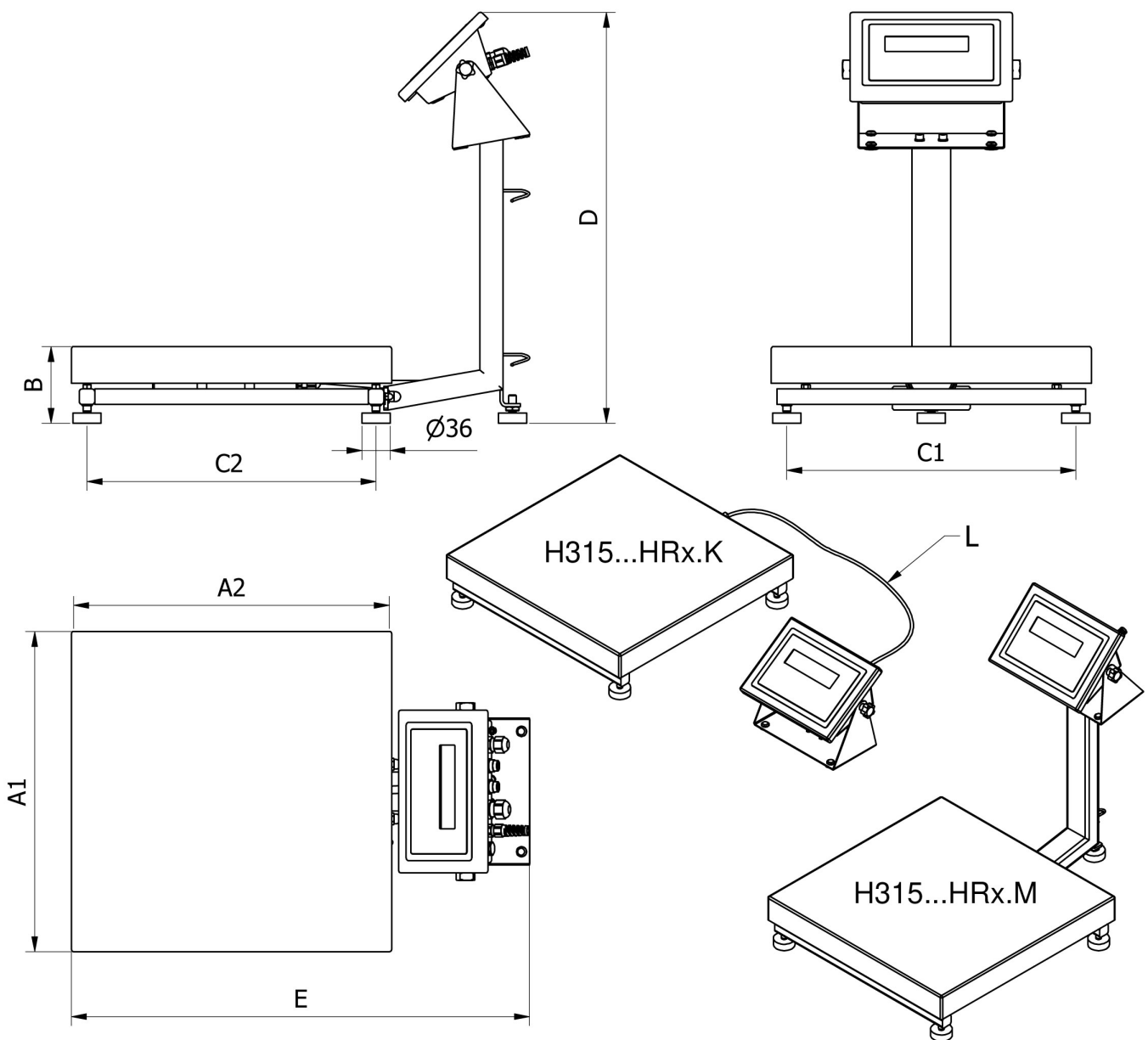

		A1	A2	B	C1	C2	D	E	L
H315...HR2.M	250 x 300	246	306	104 ± 3	208	268	~525	~483	
H315...HR2.K	250 x 300	246	306	104 ± 3	208	268	-	-	1,5m
H315...HR3.M	410 x 410	410	410	98 ± 2	370	370	~525	~587	
H315...HR3.K	410 x 410	410	410	98 ± 2	370	370	-	-	2,5m
H315...HR4.M	500 x 500	497	497	155 ± 5	400	400	~767	~650	
H315...HR4.K	500 x 500	497	497	155 ± 5	400	400	-	-	2,5m
H315...HR3/5.M	400 x 600	597	397	155 ± 5	500	300	~767	~550	
H315...HR3/5.K	400 x 600	597	397	155 ± 5	500	300	-	-	2,5m
H315...HR5.M	600 x 600	597	597	155 ± 5	500	500	~767	~750	
H315...HR5.K	600 x 600	597	597	155 ± 5	500	500	-	-	2,5m