



More information on the website
radwag.com/es/info,w1,23N

Báscula multifuncional HY10.150.C2.K



The drawings, photos and graphics used are for illustrative purposes only.

Funciones

-  Dosificación
-  Etiquetado
-  Indicador más/menos
-  Desviaciones porcentuales
-  Suma de pesajes
-  Contar piezas
-  Cierre del pesaje máximo
-  Recetas
-  Medición en Newtons
-  Estadísticas
-  Controlador de peso
-  Procedimientos GLP
-  Pesaje de animales
-  Pesaje diferencial
-  Unidades intercambiables
-  Control estadístico de calidad
-  Memoria Alibi
-  Operaciones

Datos técnicos

Parámetros metrológicos

Maxima capacidad [Max]	150 kg
Minima capacidad	1 kg
Legibilidad [d]	50 g
División de legalización [e]	50 g

Parámetros metrológicos	
Rango de tara	-150 kg
Legibilidad máxima para las balanzas no verificadas	5 g
Calibración	externa
Clase OIML	III
Parámetros físicos	
Pantalla	10,1" gráfico color pantalla táctil
Longitud del cable	2,5 m
Dimensión de platillo	400x500 mm
Dimensiones de embalaje	620x720x440 mm
Masa neta	16 kg
Masa bruta	18 kg
Construcción	
Grado de protección	IP 65 construcción, IP 68 (1h max)/69 medidor
Interface de comunicación	
Conectividad	2xRS232, 2xUSB-A, Ethernet, 4 IN / 4 OUT (digitales)
Interfaces opcionales	módulo Wi-Fi 802.11 b/g/n, módulo Profibus (DP SLAVE), módulo RS485, módulo PROFINET (RJ45), módulo de salida analógica (4-20mA, 0-20mA, 0-10V) , 12IN / 12OUT (IN – 5-24 VDC, OUT – max 30 VDC, 0,5 ADC)
Parámetros electricos	
Alimentación	100 – 240 V AC 50/60 Hz
Condiciones ambientales	
Temperatura de trabajo	-10 – +40 °C
Humedad relativa de aire	10% – 85% RH sin condensación

* Wi-Fi® is a registered trademark of Wi-Fi® Alliance.



Extra payment for verification



Accesorios

Cables RS 232 (Bascula a Impresora)
 Lector de tarjetas transpondedor
 Cables RS 232 (Bascula a Impresora ZEBRA)
 Cables de corriente (Bascula a Ethernet)
 Pantallas
 Cables RS 232, RS 485
 Cables Entradas/Salidas
 Escáner de códigos de barra
 Impresoras de etiquetas

Soportes, brazos
 Teclado, manipuladores
 Impresoras de recibos
 Pesas de clase F1 - cilíndrico sin cámara de ajuste, juegos
 Cable USB (Bascula a Impresora)
 Módulos adicionales de la plataforma
 Módulos adicionales
 Convertidor RS 232 a USB

Programas

- E2R Pesajes [WX-010-0099]
- E2R CCE [WX-010-0051]
- RAD Key [WX-010-0005]

- E2R Recetas [WX-010-0043]
- E2R Registro [WX-010-0038]
- Audit Trail Reader [WX-010-0186]

- Editor de Etiquetas R02 [WX-010-0094]
- R-LAB [WX-010-0080]
- RADWAG Development Studio [WX-010-0104]

- RADWAG Remote Desktop [WX-010-0107]
- Editor de Balanzas 2.1 [WX-010-0173]

Dimensiones de aparato

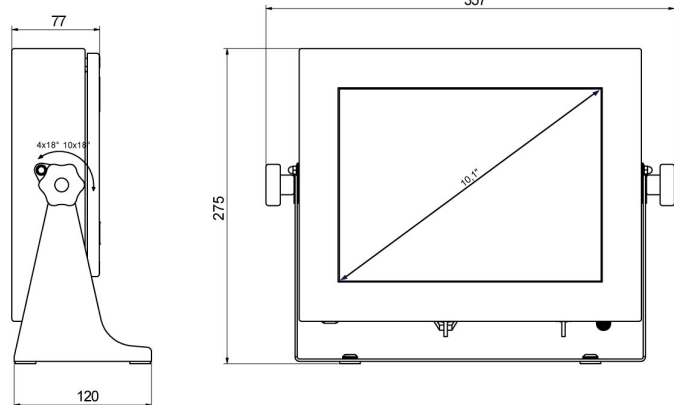

PUE HY10

Scale type	A1	A2	H
HY10.C2.K	400	500	103 ±3
HY10.C3.K	500	700	130 ±3
HY10.F1.K	300	300	70 ±3

dimensions in mm