























More information on the website
radwag.com/it/info,w1,1DE

Bilancia di precisione WLC 20.X7



The drawings, photos and graphics used are for illustrative purposes only.

funzioni

-  Autotest
-  Dosing
-  Percent Weighing
-  Parts counting
-  Peak hold
-  Formulation
-  Newton unit measurement
-  Statistics
-  Checkweighing
-  IR sensors
-  Under-pan weighing
-  GLP Procedures
-  Animal weighing
-  Density determination
-  Ambient conditions monitoring
-  Replaceable unit
-  Statistical Quality Control
-  ALIBI Memory
-  Mass for titrator
-  Wi-Fi

Foglio di calcolo

Parametri metrologici

Capacità massima [Max]	20 kg
Accuratezza	0,1 g
Intervallo di verifica della bilancia [e]	-
Intervallo di tara	-20 kg

Parametri metrologici	
Ripetibilita	0,1 g
Linearita	±0,3 g
Tempo di stabilizzazione	3 s
Calibrazione	external
Parametri fisici	
Sistema di livellamento	manualny
Display	7" graphic colour touchscreen
Dimensioni del piatto di pesata	195×195 mm
Dimensioni del pacco	430×270×190 mm
Peso netto	2,2 kg
Peso lordo	3 kg
Costruzione	
Punteggio IP	IP 43
Components and software	
Capacita del database	7
Interfaccia di comunicazione	
Interfaccia	2×RS232 ¹ , USB-A, USB-B, Ethernet, Wi-Fi
Parametri elettrici	
Alimentatore	Adapter: 100 – 240V AC 50/60Hz 0,6A; 12V DC 1,2A Balance: 10 – 15VDC 0,6A max
Environmental conditions	
Temperatura di lavoro	+10 ÷ +40 °C

* Wi-Fi® is a registered trademark of Wi-Fi® Alliance.



Accessori

Contenitore per stoccaggio bilance
Tavoli antivibranti
Alimentatore
Cavo seriale RS 232 (connessione bilance - Stampanti)
Cavo di alimentazione con spina per accendisigari
cavo USB (connessione bilance - stampanti)
Lettore di codici a barre
Under-pan weighing

Cavo seriale RS 232, RS 485
KIT determinazione della densita
Display
Stampanti di ricevuata
Cavo seriale RS 232, RS 485
Capottina protettiva per bilance
Cavo seriale RS 232 (connessione bilance - Stampanti)
RS 232 – RS 485 Converter

Software

- RAD Key [WX-010-0005]
- R-LAB [WX-010-0080]
- Software „Development Studio” RADWAG [WX-010-0104]

- „Alibi Reader” PC Software [WX-010-0114]
- Editore per sistemi di pesatura 2.1 [WX-010-0173]

Device dimensions

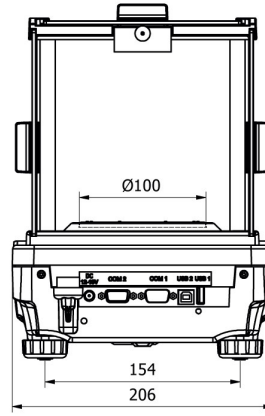
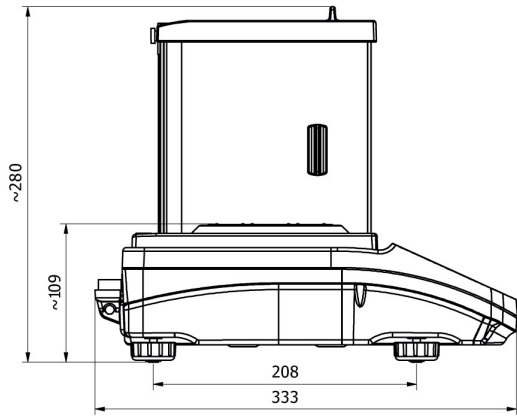

WLC X2, d = 0.001 mg

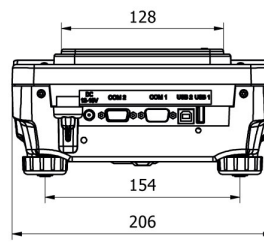
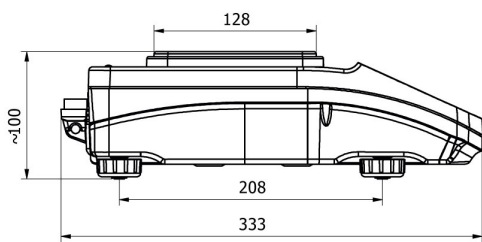

WLC X2, d = 0.01 mg

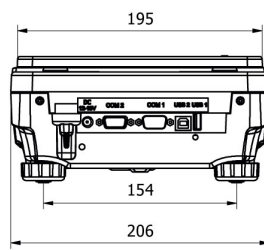
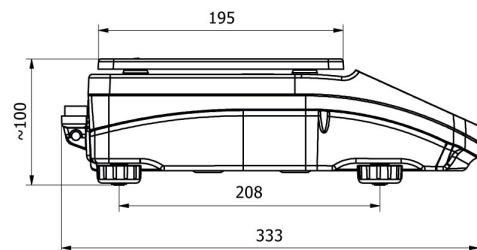

WLC X2, d = 0.1 mg