























More information on the website
radwag.com/de/info,w1,0ZC

Präzisionswaage WLC 2.X7



The drawings, photos and graphics used are for illustrative purposes only.

Funktionen

-  Autotest
-  Dosing
-  Percent Weighing
-  Parts counting
-  Peak hold
-  Formulation
-  Newton unit measurement
-  Statistics
-  Checkweighing
-  IR sensors
-  Under-pan weighing
-  GLP Procedures
-  Animal weighing
-  Density determination
-  Ambient conditions monitoring
-  Replaceable unit
-  Statistical Quality Control
-  ALIBI Memory
-  Mass for titrator
-  Wi-Fi

Technische Daten

Messtechnische Parameter	
Wägebereich [Max]	2 kg
Zifferschritt [d]	0,01 g
Eichwert [e]	-
Tarierbereich	-2 kg

Messtechnische Parameter	
Wiederholbarkeit	0,015 g
Linearität	±0,03 g
Stabilisierungszeit	2 s
Justierung	intern (automatisch)
Physikalische Parameter	
Nivelliersystem	manualny
Display	7" grafisch farbiger Touch-Screen
Lieferumfang	Waage, Waagschale, Waagschalenabdeckung, grounding bumper ×1, bumper ×3, Netzteil.
Waagschale	195×195 mm
Verpackungsgröße	430×270×190 mm
Nettogewicht	2,2 kg
Bruttogewicht	3,5 kg
Konstruktion	
Schutzart	IP 43
Komponenten und Software	
Datenbankkapazität	7
Kommunikationsschnittstellen	
Schnittstellen	2×RS232 ¹ , USB-A, USB-B, Ethernet, Wi-Fi
Elektrische Parameter	
Stromversorgung	Adapter: 100 – 240V AC 50/60Hz 0,6A; 12V DC 1,2A Waage: 10 – 15VDC 0,6A max
Umgebungsbedingungen	
Umgebungstemperatur	+10 ÷ +40 °C

Wiederholbarkeit wird als Standardabweichung von 10 Wägezyklen ausgedrückt.

Die Stabilisierungszeit ist abhängig von den Umgebungsbedingungen und der Geschwindigkeit bei Auflegen der Last auf der Waagschale; für FAST-Profil definiert.

¹ Barcode scanners, available as weighing instrument accessory, communicate with the instrument via RS232 interface exclusively.

* Wi-Fi® is a registered trademark of Wi-Fi® Alliance.



Zubehör

Waagenkoffer
 Antivibrationstische
 Netzteile
 Kabel RS 232 (Waage – Drucker)
 Anschlusskabel für Zigarettenanzünder
 USB-Kabel (Waage – Drucker)
 Barcodescanner
 Unterflurwägung

Kabel RS 232, RS 485
 Dichtebestimmungsset
 Displays
 Thermische Drucker
 Kabel RS 232, RS 485
 Schutzhauben
 Kabel RS 232 (Waage – Drucker)
 Konverter RS 232 – RS 485

Software

- RAD Key [WX-010-0005]
- RLAB [WX-010-0080]
- RADWAG Development Studio [WX-010-0104]

- Alibi Reader [WX-010-0114]
- Scale Editor 2.1 [WX-010-0173]

Abmessungen des Geräts

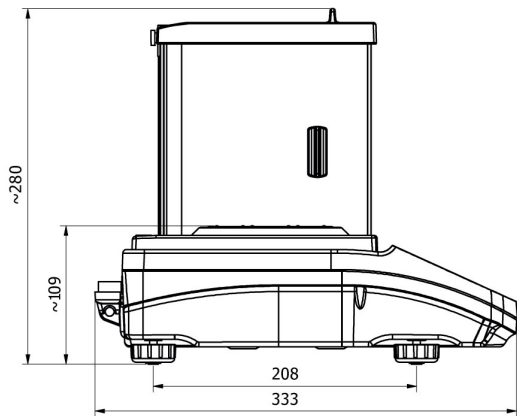

WLC X2, d = 0.001 mg

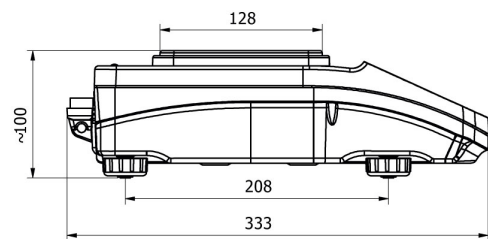
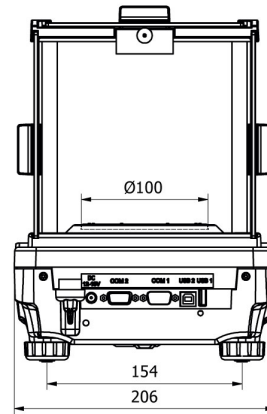

WLC X2, d = 0.01 mg

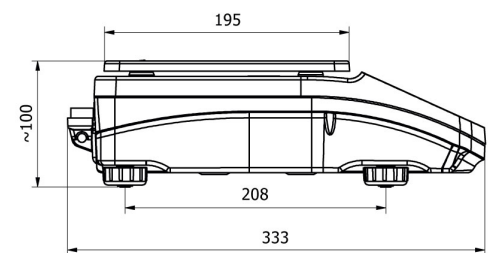
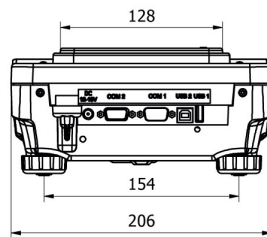

WLC X2, d = 0.1 mg

