

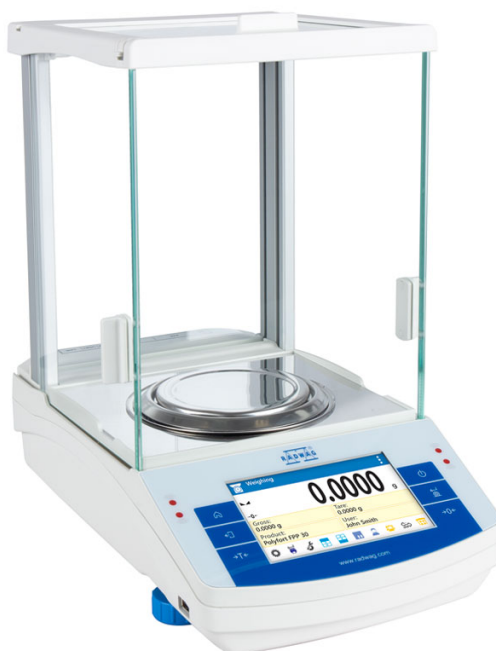





















More information on the website
radwag.com/it/info,w1,0QU

Bilancia analitica AS 520.X2 PLUS



The drawings, photos and graphics used are for illustrative purposes only.

Funzioni

-  Autotest
-  Dosing
-  Plus/Minus Control
-  Percent Weighing
-  Parts counting
-  Peak hold
-  Formulation
-  Newton unit measurement
-  Statistics
-  Checkweighing
-  IR sensors
-  GLP Procedures
-  Animal weighing
-  Density determination
-  Ambient conditions monitoring
-  Replaceable unit
-  Statistical Quality Control
-  ALIBI Memory
-  Mass for titrator
-  Wi-Fi

Specifiche

Parametri metrologici	
Portata massima [Max]	520 g
Portata minima [Min]	-
Divisione [d]	0,1 mg
Campo di tara	-520 g

Parametri metrologici	
Ripetibilità standard [5% Max]	0,07 mg
Ripetibilità standard [Max]	0,2 mg
Peso standard minimo (USP)	140 mg
Peso standard minimo (U = 1%, k = 2)	14 mg
Ripetibilità consentita [5% massimo]	0,12 mg
Ripetibilità consentita [Max]	0,4 mg
Linearità	±0,6 mg
Tempo di stabilizzazione	2,5 s
Calibrazione	internal (automatic)
Classe OIML	I
Parametri fisici	
Sistema di livellamento	semi-automatic – LevelSENSING
Display	5" graphic color touchscreen
Porta della camera di pesatura	manual
Componenti del kit	Balance, weighing pan, weighing pan shield, bottom cover, power supply.
Dimensioni della camera di pesata	190×190×226 mm
Dimensione piatto	ø100 mm
Dimensioni del pacco	490×400×520 mm
Peso netto	7,3 kg
Peso lordo	9 kg
Costruzione	
Punteggio IP	IP 43
Components and software	
Capacità del database	7
Caratteristiche operative	
Operazione senza comandi diretti	2 IR Sensors
Interfaccia di comunicazione	
Interfaccia	RS232 ¹ , 2×USB-A (interchangeable), USB-B, Wi-Fi, Ethernet
Parametri elettrici	
Alimentatore	Adapter: 100 – 240V AC 50/60Hz 0,6A; 12V DC 1,2A Balance: 12 – 15V DC 0,8A max
Massimo assorbimento elettrico	4 W
Environmental conditions	
Ambiente di lavoro	+10 – +40 °C
Modulo misura parametri ambientali (opzionale)	THBR 2.0 System, THBR BOX, THB P, THB W, THB S
Umidità relativa	40% – 80%

La ripetibilità è espressa come deviazione standard di 10 posizionamenti dello standard di massa.

Il tempo di stabilizzazione dipende dalle condizioni esterne e dalla dinamica di posizionamento del carico sul piatto; specificato per il profilo FAST.

¹Gli lettori di codici a barre disponibili come accessorio funzionano con la bilancia utilizzando solo l'interfaccia RS232.

* Wi-Fi® is a registered trademark of Wi-Fi® Alliance.



Accessori

Tavoli antivibranti
supporti per beute da laboratorio
Alimentatore
Cavo di alimentazione con spina per accendisigari
KIT determinazione della densità
cavo USB (connessione bilance - stampanti)
Tavolo di pesata professionale
Lettore di codici a barre
supporti per provette e filtri
Stazione di lavoro per calibrazione pipette
Cavo seriale RS 232, RS 485

THBR 2.0 - modulo misura parametri ambientali
Display
Capottina protettiva per bilance
Recipienti per pesare
Ionizzatore anti statico
Stampanti di ricevuta
Cavo seriale RS 232, RS 485
Moduli aggiuntivi
Pesatura sottopensile
Cavo seriale RS 232 (connessione bilance - Stampanti)
RS 232 – RS 485 Converter

Software

- RAD Key [WX-010-0005]
- R-LAB [WX-010-0080]
- Software „Development Studio“ RADWAG [WX-010-0104]

- „Alibi Reader“ PC Software [WX-010-0114]
- Editore per sistemi di pesatura 2.1 [WX-010-0173]

Device dimensions

AS X2 PLUS, d = 0.01 mg

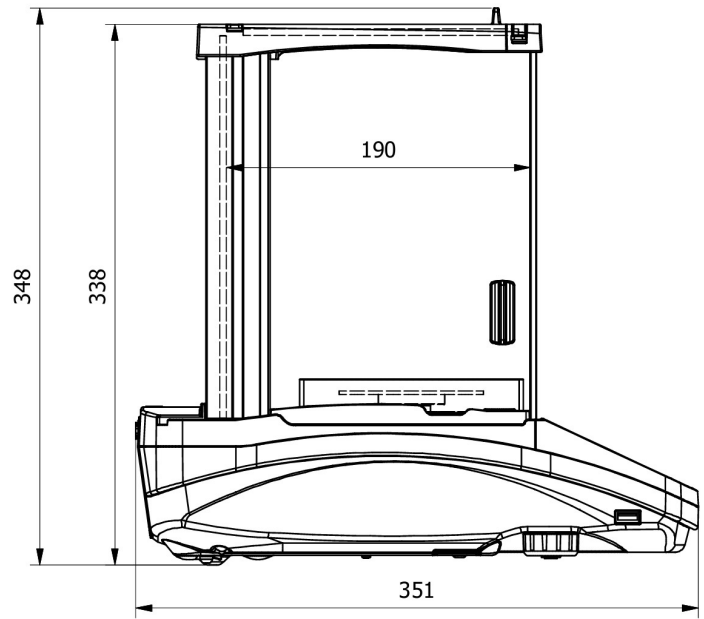

AS X2 PLUS, d = 0.1 mg

