

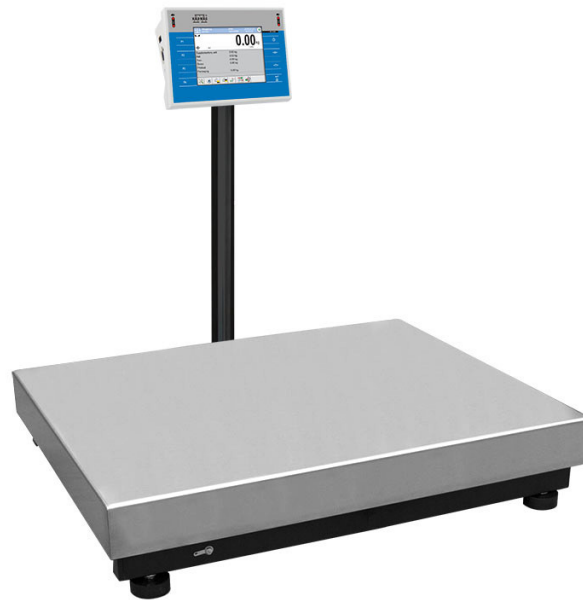

















More information on the website
radwag.com/us/info,w1,0MS

WPY 30/C2 Multifunctional Scale



The drawings, photos and graphics used are for illustrative purposes only.

Functions

-  Dosing
-  Labelling
-  Plus/Minus Control
-  Percent Weighing
-  Totalizing
-  Parts counting
-  Peak hold
-  Formulation
-  Newton unit measurement
-  Statistics
-  Checkweighing
-  IR sensors
-  Animal weighing
-  Differential weighing
-  ALIBI Memory

Datasheet

Maximum capacity [Max]	30 kg
Minimum load	200 g
Readability [d]	10 g
Tare range	-30 kg
Max readability for non-verified scale	1 g
Stabilization time	2 s

Adjustment	external
OIML Class	III
Physical parameters	
Display	5,7" Resistive Color Touchscreen
Weighing pan dimensions	400x500 mm
Packaging dimensions	720x620x210 mm
Net weight	11,1 kg
Gross weight	13,1 kg
Construction	
Protection class	IP 43
Communication interface	
Communication interface	2xRS232, 2xUSB-A, Ethernet, 4 IN / 4 OUT (digital), Wi-Fi
Power supply	
Power supply	100 – 240 V AC 50/60 Hz
Operating temperature	
Operating temperature	-10 – +40 °C

* Wi-Fi® is a registered trademark of Wi-Fi® Alliance.



Extra payment for verification



Accessories

Transponder card readers
 RS 232 cables (scale - printer)
 Cigarette lighter receptacle power supply cables
 Barcode scanners
 RS 232, RS 485 cables
 Label Printers
 Antivibration tables
 Displays
 IN/OUT Cables

Keypad, external switches
 Stands, wall mounting kits and mounting brackets
 Receipt Printer
 F1 Mass Standard - knob weights without adjustment chamber, set
 AP2-1 Current Loop Unit
 RS 232, RS 485 cables
 Additional Weighing platforms Module
 RS 232 – USB Converter
 RS 232 cables (scale - printer)

Software

- E2R Weighing [WX-010-0099]
- E2R PGC [WX-010-0051]
- RAD Key [WX-010-0005]
- Label Editor R02 [WX-010-0094]
- Scale Editor - EWAG 2.1 [WX-010-0173]

- E2R Formulations [WX-010-0043]
- E2R Weighing Records [WX-010-0038]
- Audit Trail Reader [WX-010-0186]
- RADWAG Remote Desktop [WX-010-0107]
- RADWAG Development Studio [WX-010-0104]

Device dimensions

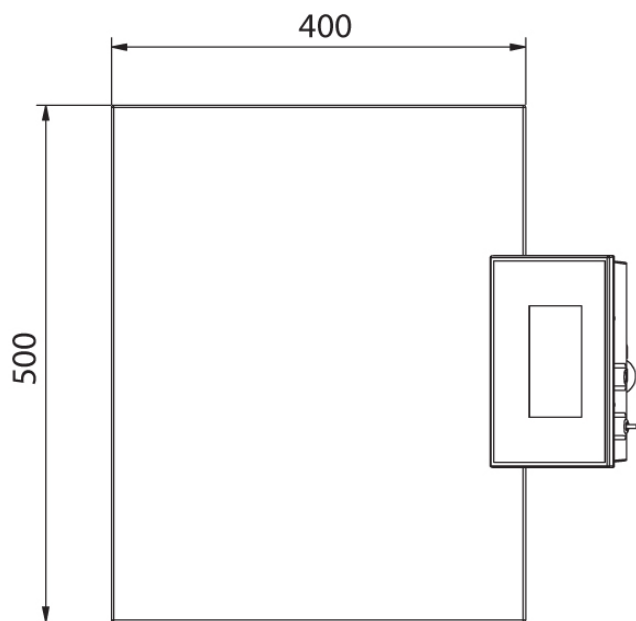
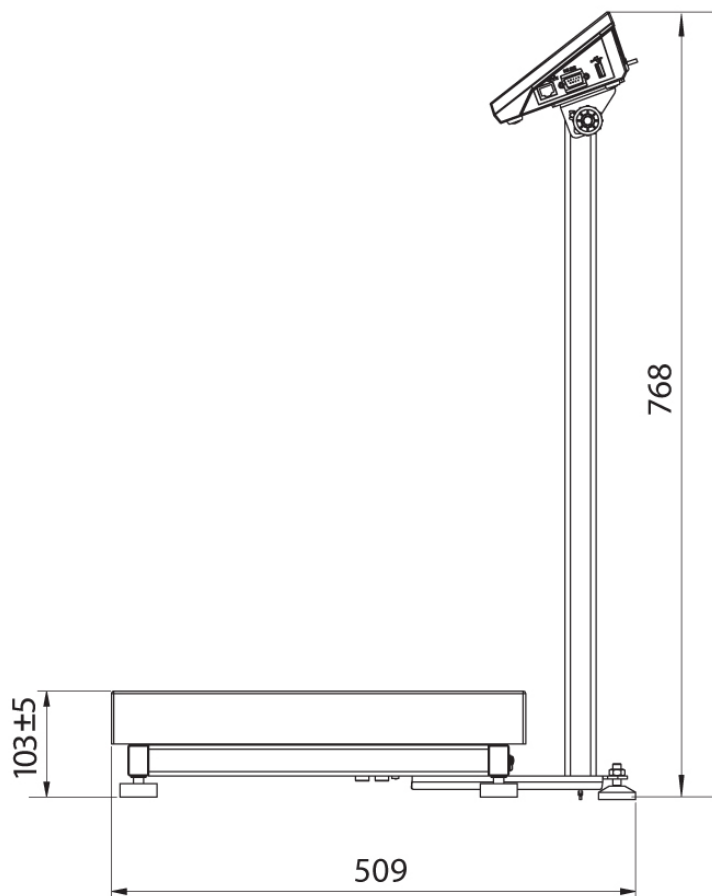

WPY C2/M