

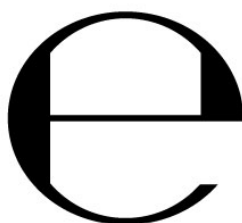

















More information on the website
radwag.com/it/info,w1,0KW

Bilancia WLY 60/120.C2.R.PGC



The drawings, photos and graphics used are for illustrative purposes only.

funzioni

-  Dosing
-  Labelling
-  Plus/Minus Control
-  Percent Weighing
-  Totalizing
-  Parts counting
-  Peak hold
-  Formulation
-  Newton unit measurement
-  Statistics
-  Checkweighing
-  IR sensors
-  Animal weighing
-  Differential weighing
-  Packaged Goods Control
-  ALIBI Memory

Foglio di calcolo

Parametri metrologici	
Capacità massima [Max]	60 / 120 kg
Pesata minima	0,5 kg
Accuratezza	10 / 20 g
Intervallo di verifica della bilancia [e]	10 / 20 g
Intervallo di tara	-120 kg
Ripetibilità	10 / 20 g

Parametri metrologici	
Linearità	±10 / 20 g
Tempo di stabilizzazione	3 s
Calibrazione	external
Classe OIML	II
Parametri fisici	
Sistema di livellamento	manual
Display	5,7" Resistiv-Farb-Touchscreen
Dimensioni del piatto di pesata	400x500 mm
Dimensioni del pacco	720x620x210 mm
Peso netto	12,5 kg
Peso lordo	15 kg
Costruzione	
Punteggio IP	IP 43
Interfaccia di comunicazione	
Interfaccia	2xRS232, 2xUSB-A, Ethernet, 4 IN / 4 OUT (digital), Wi-Fi
Parametri elettrici	
Alimentatore	Adapter: 100 – 240V AC 50/60Hz 1A; 15V DC 2,4A Balance: 10 – 28V DC 1A max
Environmental conditions	
Temperatura di lavoro	+15 ÷ +30 °C
Temperatura di stoccaggio	-25 - +70 °C
Umidità atmosferica	10% ÷ 85% RH no condensation

* Wi-Fi® is a registered trademark of Wi-Fi® Alliance.



Accessori

Lettore di tessere transponder
Alimentatore
Cavo seriale RS 232 (connessione bilance - Stampanti)
Cavo di alimentazione con spina per accendisigari
Lettore di codici a barre
Under-pan weighing
Cavo seriale RS 232, RS 485
stampanti per etichette
Moduli aggiuntivi
Display

cavi IN/OUT
Tastiera, interruttori esterni
Supporto, set di montaggio a muro e braccetti di montaggio
Stampanti di ricevuata
Pesi standard F1 - cilindrici, set
AP2-1 Power loop output
Cavo seriale RS 232, RS 485
Moduli aggiuntivi della piattaforma
RS 232 – USB Converter
Cavo seriale RS 232 (connessione bilance - Stampanti)

Software

- E2R Weighing [WX-010-0099]
- E2R Weighing Records [WX-010-0038]
- Audit Trail Reader [WX-010-0186]
- RADWAG Remote Desktop [WX-010-0107]

- E2R PGC [WX-010-0051]
- RAD Key [WX-010-0005]
- Editore di etichette R02 [WX-010-0094]
- R-LAB [WX-010-0080]

Device dimensions

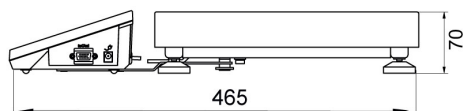

F1 version

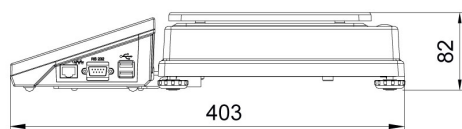
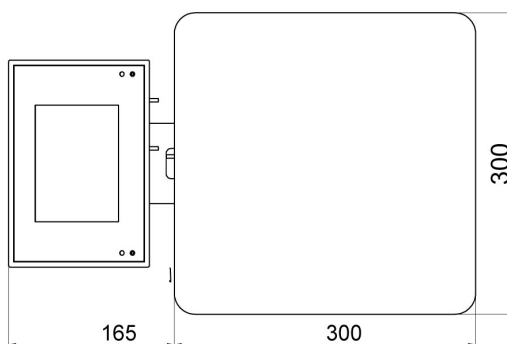

D2 version

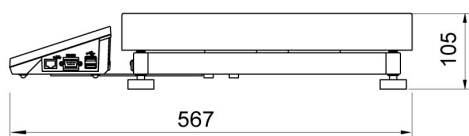
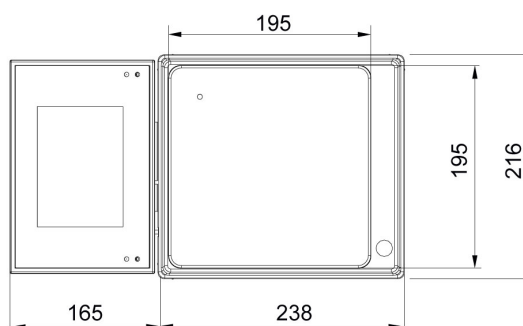

C2 version

