



More information on the website  
[radwag.com/it/info,w1,09D](http://radwag.com/it/info,w1,09D)

# Bilancia multifunzione C32.6.F1.K



The drawings, photos and graphics used are for illustrative purposes only.

## Funzioni



Labelling



Plus/Minus Control



Percent Weighing



Totalizing



Parts counting



Newton unit measurement



Statistics



IR sensors



GLP Procedures



Replaceable unit



ALIBI Memory

## Specifiche

### Parametri metrologici

Portata massima [Max]	6 kg
Portata minima [Min]	40 g
Divisione [d]	2 g
Campo di tara	-6 kg
Massima leggibilità per bilance non verificate	0,2 g
Classe OIML	III

Parametri fisici	
Display	5" graphic colour
Lunghezza del cavo	1 m
Dimensione piatto	300×300 mm
Dimensioni del pacco	570×390×170 mm
Peso netto	5,3 kg
Peso lordo	6,1 kg
Costruzione	
Punteggio IP	IP 65 construction, IP 43 terminal
Costruzione	mild steel St3S
Materiale da pesata	Stainless steel AISI304
Interfaccia di comunicazione	
Interfaccia	2×RS232, USB-A, USB-B, Ethernet, 4 IN / 4 OUT (digital), Wi-Fi
Parametri elettrici	
Alimentatore	100 – 240 V AC 50/60 Hz
Massimo assorbimento elettrico	10 W
Alimentatore opzionale	internal rechargeable battery
Tempo operativo delle batterie	operation time up to 5 h
Environmental conditions	
Ambiente di lavoro	-10 – +40 °C

\* Equipaggiamento opzionale a pagamento

\* Wi-Fi® is a registered trademark of Wi-Fi® Alliance.



Extra payment for verification



## Accessori

Display  
 Alimentatore  
 Cavo seriale RS 232 (connessione bilance - Stampanti)  
 Cavo di alimentazione con spina per accendisigari  
 Lettore di codici a barre  
 Cavo seriale RS 232, RS 485  
 stampanti per etichette  
 Display

Display  
 Tastiera, interruttori esterni  
 Supporto, set di montaggio a muro e braccetti di montaggio  
 Moduli aggiuntivi  
 Stampanti di ricevuta  
 Cavo seriale RS 232, RS 485  
 Cavo seriale RS 232 (connessione bilance - Stampanti)

## Software

- E2R Weighing [WX-010-0099]
- RAD Key [WX-010-0005]
- „Alibi Reader” PC Software [WX-010-0114]
- Editore per sistemi di pesatura 2.1 [WX-010-0173]

- E2R Weighing Records [WX-010-0038]
- Editore di etichette R02 [WX-010-0094]
- R-LAB [WX-010-0080]
- Software „Development Studio” RADWAG [WX-010-0104]

# Device dimensions

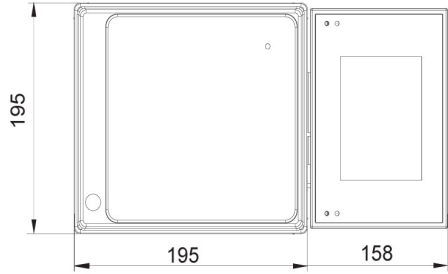
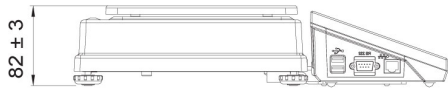

C32.D2

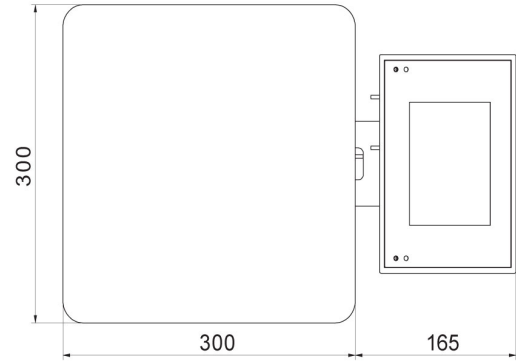
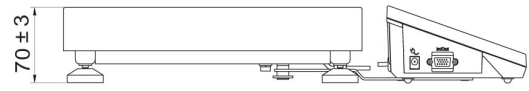

C32.F1.R

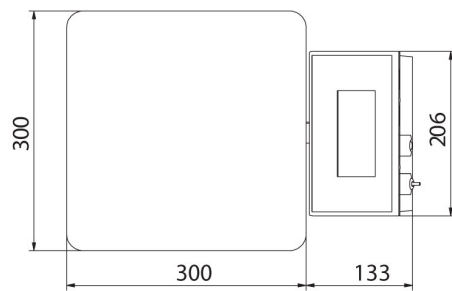
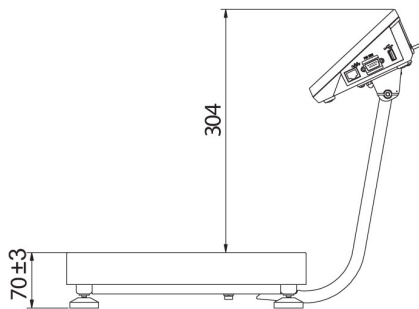

C32.F1.M

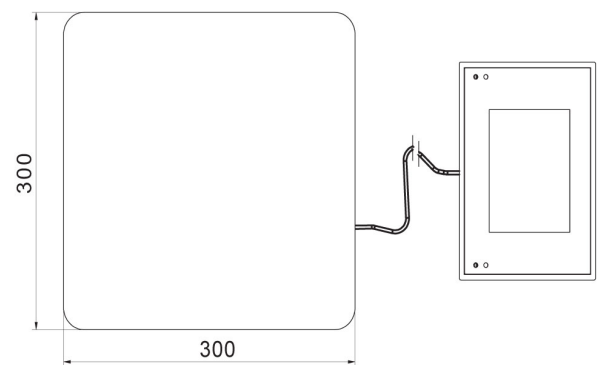
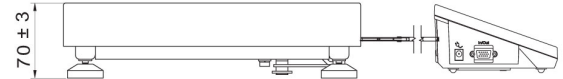

C32.F1.K