

ANALYTICAL BALANCES AS/X



release date 31-10-2012













Balances series AS/X represent standard level of analytical balances. They feature backlit graphic display. Measurement accuracy and reliability is determined by automatic internal adjustment/calibration system, triggered by time flow and temperature conditions.

The highlight of AS/X series is generation of GLP procedure in a form of printout from standard or custom configured report from balance adjustment/calibration process.

User accesses balance's weighing pan through a big weighing chamber with sliding top and side glass doors. Each balance series AS/X features RS 232 and USB output and additional display slot.

AS/X series offers the possibility of weighing loads outside the main weighing platform (i.e. under hook weighing). This means of measurement is an alternative for weighing loads with non-standard dimensions and shapes and those create magnetic field. Under hook weighing is also applied for density determination procedures.

-  Parts counting
-  Filling
-  Animal weighing
-  Density determination
-  Checkweighing
-  Percent setup
-  Statistics
-  Formulation
-  Air buoyancy correction
-  GLP procedures
-  Under-hook weighing

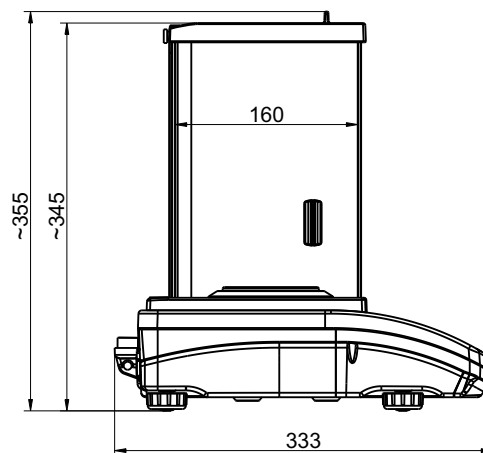
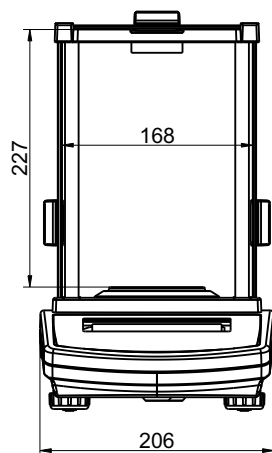

Technical data:

	AS 110/X M	AS 160/X M	AS 220/X M	AS 310/X M
Max capacity	110 g	160 g	220 g	310 g
Minimal load	10 mg	10 mg	10 mg	10 mg
Readability	0,1 mg	0,1 mg	0,1 mg	0,1 mg
Tare range	-110 g	-160 g	-220 g	-310 g
Working temperature	+10° ÷ +40°C			
Relative air humidity **	40% ÷ 80%			
Stabilization time	3,5 s			
Repeatability *	0,1 mg	0,1 mg	0,1 mg	0,1 mg (220g) 0,2 mg (220g÷310g)
Linearity	± 0,2 mg	± 0,2 mg	± 0,2 mg	± 0,3 mg
Sensitivity drift	1 ppm/°C in temperature +15° ÷ +35°C			
Interface	RS 232, USB			
Power supply	13,5 ÷ 16 V DC / 2,1 A			
Adjustment / Calibration	internal (automatic)			
Pan size	ø 85 mm	ø 85 mm	ø 85 mm	ø 85 mm
Net weight / Gross weight	5,5/8,2 kg	5,6/8,3 kg	5,6/8,3 kg	5,6/8,3 kg
Packaging dimensions	495 × 385 × 515 mm			

* Repeatability is expressed as a standard deviation from 10 weighing cycles.

** Non-condensing conditions

Additional equipment:

Antivibration table for laboratory balances	Density determination kit
Professional weighing table	Additional LCD display "WD-3/01"
Kafka thermal printer	PC keyboard
Dot matrix Epson printer	Additional adapter for pipettes calibration
Label printer Citizen	Power adapter with battery and charger ZR-02
Holders for glass vessels	Rack for under hook weighing
Tare and "Print" foot button	Standard mass
PW-WIN computer software	Antistatic cable
RAD-KEY computer software	Cable RS 232 (scale - Kafka printer) "P0136"
REC-FS computer software	Cable RS 232 (scale - computer) "P0108"
Antistatic ionizer DJ-02	Cable RS 232 (scale, Epson , Citizen printer) "P0151"
Ambient conditions module	